

EMC TEST REPORT For

MAGNIZON POWER SYSTEMS FZE

Big power inverter

Model Number: APS-2048SW-LCD, APS-3048SW-LCD, APS-4048SW-LCD,
APS-5048SW-LCD, APS-6048SW-LCD, APS-8048SW-LCD, APS-10K48SW-LCD,
APS-12K48SW-LCD

Prepared for : MAGNIZON POWER SYSTEMS FZE
Address : JAFZA LB11, 1st floor, Office 32 Jebel ali Free Zone,
Dubai-UAE PO Box no: 263819

Prepared by : EMTEK (SHENZHEN) CO., LTD.
Address : Bldg 69, Majialong Industry Zone,
Nanshan District, Shenzhen, Guangdong, China

Tel: (0755) 26954280
Fax: (0755) 26954282

Report Number : ES150529360E-3
Date of Test : June 04, 2015 to July 03, 2015
Date of Report : July 06, 2015

TABLE OF CONTENT

Description	Page
1. SUMMARY OF TEST RESULT	7
2. GENERAL INFORMATION	8
2.1. Description of Device (EUT).....	8
2.2. Description of Support Device.....	8
2.3. Description of Test Facility.....	8
2.4. Measurement Uncertainty	9
3. MEASURING DEVICE AND TEST EQUIPMENT	10
3.1. For Conducted Emission Measurement.....	10
3.2. For Radiated Emission Measurement.....	10
3.3. For Harmonic Current / Flicker Measurement.....	10
3.4. For Electrostatic Discharge Immunity Test.....	10
3.5. For RF Strength Susceptibility Test.....	11
3.6. For Electrical Fast Transient /Burst Immunity Test.....	11
3.7. For Surge Immunity Test	11
3.8. For Injected Current Susceptibility Test.....	11
3.9. For Magnetic Field Immunity Test	12
3.10. Low Frequency Signals Test	12
4. CONDUCTED EMISSION MEASUREMENT	13
4.1. Block Diagram of Test Setup.....	13
4.2. Measuring Standard	13
4.3. EUT Configuration on Measurement.....	13
4.4. Operating Condition of EUT	13
4.5. Test Procedure	14
4.6. Measuring Results.....	14
5. RADIATED EMISSION MEASUREMENT	23
5.1. Block Diagram of Test	23
5.2. Measuring Standard	23
5.3. Radiated Emission Limits	23
5.4. EUT Configuration on Test	24
5.5. Operating Condition of EUT	24
5.6. Test Procedure	24
5.7. Measuring Results.....	24
6. HARMONIC CURRENT EMISSION MEASUREMENT	33
6.1. Block Diagram of Test Setup.....	33
6.2. Measuring Standard	33
6.3. Operation Condition of EUT	33
6.4. Measuring Results.....	33
7. VOLTAGE FLUCTUATION AND FLICKER MEASUREMENT	37
7.1. Block Diagram of Test Setup.....	37
7.2. Measuring Standard	37
7.3. Operation Condition of EUT	37
7.4. Measuring Results.....	37
8. IMMUNITY PERFORMANCE CRITERIA DESCRIPTION	39
9. ELECTROSTATIC DISCHARGE IMMUNITY TEST.....	41
9.1. Block Diagram of Test Setup.....	41
9.2. Test Standard	41

9.3. Severity Levels and Performance Criterion	41
9.4. EUT Configuration	42
9.5. Operating Condition of EUT	42
9.6. Test Procedure	42
9.7. Test Results	42
10. RF FIELD STRENGTH SUSCEPTIBILITY TEST	44
10.1. Block Diagram of Test	44
10.2. Test Standard	44
10.3. Severity Levels and Performance Criterion	45
10.4. EUT Configuration on Test	45
10.5. Operating Condition of EUT	45
10.6. Test Procedure	45
10.7. Test Results	46
11. ELECTRICAL FAST TRANSIENT/BURST IMMUNITY TEST	48
11.1. Block Diagram of Test Setup	48
11.2. Test Standard	48
11.3. Severity Levels and Performance Criterion	48
11.4. EUT Configuration	49
11.5. Operating Condition of EUT	49
11.6. Test Procedure	49
11.7. Test Result	49
12. SURGE IMMUNITY TEST	51
12.1. Block Diagram of Test Setup	51
12.2. Test Standard	51
12.3. Severity Levels and Performance Criterion	51
12.4. EUT Configuration	52
12.5. Operating Condition of EUT	52
12.6. Test Procedure	52
12.7. Test Result	52
13. INJECTED CURRENTS SUSCEPTIBILITY TEST	54
13.1. Block Diagram of Test Setup	54
13.2. Test Standard	54
13.3. Severity Levels and Performance Criterion	54
13.4. EUT Configuration	55
13.5. Operating Condition of EUT	55
13.6. Test Procedure	55
13.7. Test Results	55
14. MAGNETIC FIELD SUSCEPTIBILITY TEST	57
14.1. Block Diagram of Test	57
14.2. Test Standard	57
14.3. Severity Levels and Performance Criterion	57
14.4. EUT Configuration on Test	58
14.5. Test Procedure	58
14.6. Test Results	58
15. LOW FREQUENCY SIGNALS TEST	60
15.1. Block Diagram of Test Setup	60
15.2. Test Standard	60
15.3. Operating Condition of EUT	60
15.4. Test Results	60
16. TEST PHOTOGRAPH	62
16.1. Photos of Conducted Emission Measurement	62
16.2. Photo of Radiation Emission Measurement	63
16.3. Photo of Harmonic Measurement	64
16.4. Photo of Electrostatic Discharge Test	64
16.5. Photo of RF Field Strength susceptibility Test	65

16.6. Photos of Electrical Fast Transient /Burst Test.....65
16.7. Photo of Surge Test.....66
16.8. Photo of Injected Currents Susceptibility Test.....66
16.9. Photo of Magnetic Field Immunity Test67
16.10. Photo of Low Frequency Signals Test.....67

APPENDIX (Photos of EUT) (5 Pages)

TEST REPORT VERIFICATION

Applicant : MAGNIZON POWER SYSTEMS FZE
Manufacturer : MAGNIZON POWER SYSTEMS FZE
EUT : Big power inverter
Trademark : SUMRY
Model Number : APS-2048SW-LCD, APS-3048SW-LCD, APS-4048SW-LCD,
APS-5048SW-LCD, APS-6048SW-LCD, APS-8048SW-LCD,
APS-10K48SW-LCD, APS-12K48SW-LCD
Power Supply : AC 230V, 50Hz or DC 48V

Measurement Procedure Used:

EN 62040-2: 2006, IEC 62040-2:2005
EN 61000-3-12:2011
(IEC 61000-4-2:2008, IEC 61000-4-3:2006+A1:2007+A2:2010, IEC61000-4-4:2012,
IEC 61000-4-5:2005, IEC 61000-4-6:2008, IEC 61000-4-8:2009, IEC 61000-4-11:2004,
IEC 61000-2-2:2002, IEC 61000-3-12:2011)

The device described above is tested by EMTEK (SHENZHEN) CO., LTD. to determine the maximum emission levels emanating from the device and the severe levels of the device can endure and its performance criterion. The measurement results are contained in this test report and EMTEK (SHENZHEN) CO., LTD. is assumed full of responsibility for the accuracy and completeness of these measurements. Also, this report shows that the EUT (Equipment Under Test) is technically compliant with the EN 62040-2 requirements.

In this report the model and configuration chosen for each test is representative for all models or configurations (defined in the user manual) by using The "Worst Case" approach of the Guide for the EMC Directive 2014/30/EU.

This report applies to above tested sample only and shall not be reproduced in part without written approval of EMTEK (SHENZHEN) CO., LTD.

Date of Test : June 04, 2015 to July 03, 2015

Prepared by : 
Jessie Hu/Editor

Reviewer : 
Joe Xia/Supervisor



Approved & Authorized Signer : 
Lisa Wang/Manager

Modified Information

Version	Report No.	Revision Date	Summary
Ver.1.0	ES150529360E	2015-06-04	Original Report
Ver.1.0	ES150529360E-3	2016-06-01	<ol style="list-style-type: none">1. Change applicant and trademark2. Change EUT name and model number

1. SUMMARY OF TEST RESULT

EMISSION			
Description of test item	Standard	Limits	Results
Conducted disturbance at mains terminals and Telecommunication Ports	EN62040-2: 2006	C2	Pass
Radiated Disturbance	EN62040-2: 2006	C2	Pass
Harmonic Current Emission	EN 61000-3-12:2011	Class A	Pass
Immunity			
Description of test item	Basic Standard	Performance Criteria	Observation Criteria
Electrostatic Discharge (ESD)	IEC 61000-4-2:2008	B	A
Radio-frequency, Continuous radiated disturbance	IEC 61000-4-3:2006+A1:2007+A2:2010	A	A
EFT/B Immunity	IEC61000-4-4:2012	B	B
Surge Immunity	IEC 61000-4-5:2005	B	A
Conducted RF Immunity	IEC 61000-4-6:2008	A	A
Power frequency magnetic field	IEC 61000-4-8:2009	A	A
Voltage dips and Voltage interruptions	IEC 61000-4-11:2004	B	N/A
Low Frequency signals	IEC 61000-2-2:2002	A	A
Note: /			

2. GENERAL INFORMATION

2.1. Description of Device (EUT)

EUT	: Big power inverter
Model Number	: APS-2048SW-LCD, APS-3048SW-LCD, APS-4048SW-LCD, APS-5048SW-LCD, APS-6048SW-LCD, APS-8048SW-LCD, APS-10K48SW-LCD, APS-12K48SW-LCD (Note: These models are identical in circuitry and electrical, mechanical and physical construction; the only differences are the output electric rating, parts of output component parameters & turns of transformer secondary and model no. For trading purpose. We prepare APS-3048SW-LCD, APS-5048SW-LCD for test.)
Test voltage	: AC 230V/50Hz, DC 48V
Applicant	: MAGNIZON POWER SYSTEMS FZE
Address	: JAFZA LB11, 1st floor, Office 32 Jebel ali Free Zone, Dubai-UAE PO Box no: 263819
Manufacturer	: MAGNIZON POWER SYSTEMS FZE
Address	: JAFZA LB11, 1st floor, Office 32 Jebel ali Free Zone, Dubai-UAE PO Box no: 263819
Date of receiver	: June 04, 2015
Date of Test	: June 04, 2015 to July 06, 2015

2.2. Description of Support Device

N/A : N/A

2.3. Description of Test Facility

Site Description EMC Lab.	: Accredited by CNAS, 2013.10.29 The certificate is valid until 2016.10.28 The Laboratory has been assessed and proved to be in compliance with CNAS-CL01: 2006 (identical to ISO/IEC 17025: 2005) The Certificate Registration Number is L2291. Accredited by TUV Rheinland Guangzhou 2010.5.25 The Laboratory has been assessed according to the requirements ISO/IEC 17025 Accredited by FCC, April 17, 2013 The Certificate Registration Number. is 709623. Accredited by Industry Canada, November 24, 2015 The Certificate Registration Number. is 4480A
Name of Firm Site Location	: EMTEK (SHENZHEN) CO., LTD. : Bldg 69, Majialong Industry Zone, Nanshan District, Shenzhen, Guangdong, China

2.4. Measurement Uncertainty

Test Item	Uncertainty
Conducted Emission Uncertainty	: 3.16dB(9k~150kHz Conduction 2#) 2.90dB(150k-30MHz Conduction 2#)
Radiated Emission Uncertainty (10m Chamber)	: 3.96dB (30M~1GHz Polarize: H) 4.04dB (30M~1GHz Polarize: V)
Uncertainty for Harmonic test	: 1.8%
Uncertainty for C/S Test	: 1.45(Using CDN Test)
Uncertainty for R/S Test	: 2.10dB(80MHz-200MHz) 1.76dB(200MHz-1000MHz)
Uncertainty for test site temperature and humidity	: 0.6°C 4%

3. MEASURING DEVICE AND TEST EQUIPMENT

3.1. For Conducted Emission Measurement

Used	Equipment	Manufacturer	Model No.	Serial No.	Last Cal.	Cal. Interval
<input checked="" type="checkbox"/>	L.I.S.N.	ROHDE & SCHWARZ	ESH3-Z6	100011	May 16, 2015	1 Year
<input checked="" type="checkbox"/>	L.I.S.N.	ROHDE & SCHWARZ	ESH3-Z6	100253	May 16, 2015	1 Year
<input checked="" type="checkbox"/>	50Ω Coaxial Switch	Anritsu	MP59B	M20531	May 16, 2015	1 Year
<input checked="" type="checkbox"/>	Pulse Limiter	Rohde & Schwarz	ESH3-Z2	100006	May 16, 2015	1 Year
<input checked="" type="checkbox"/>	L.I.S.N.	ROHDE & SCHWARZ	ESH3-Z6	100011	May 16, 2015	1 Year

3.2. For Radiated Emission Measurement

Used	Equipment	Manufacturer	Model No.	Serial No.	Last Cal.	Cal. Interval
<input checked="" type="checkbox"/>	EMI Test Receiver	Rohde & Schwarz	ESCI	101045	May 16, 2015	1 Year
<input checked="" type="checkbox"/>	Pre-Amplifier	CDIL	PAP-0203	22013	May 16, 2015	1 Year
<input checked="" type="checkbox"/>	Bilog Antenna	Schwarzbeck	VULB9163	143	May 16, 2015	1 Year
<input checked="" type="checkbox"/>	Cable	H+B	CBL3-MN-0.5m	100319-2140500-1	May 16, 2015	1 Year
<input checked="" type="checkbox"/>	Cable	H+B	CBL3-NN-3m	100319-2143000-1	May 16, 2015	1 Year
<input checked="" type="checkbox"/>	Cable	H+B	CBL3-MN-6.5m	100319-2146500-1	May 16, 2015	1 Year
<input checked="" type="checkbox"/>	Cable	H+B	CBL3-NN-10.5m	100319-21410500	May 16, 2015	1 Year
<input type="checkbox"/>	Cable	H+B	CBL3-NN-12.5m	100319-21412500	May 16, 2015	1 Year

3.3. For Harmonic Current / Flicker Measurement

Used	Equipment	Manufacturer	Model No.	Serial No.	Last Cal.	Cal. Interval
<input checked="" type="checkbox"/>	45KVA AC Power source	Teseq	NSG 1007-45/45K VA	1305A02873	May 16, 2015	1 Year
<input checked="" type="checkbox"/>	Signal conditioning Unit	Teseq	CCN 1000-3	1305A02873	May 16, 2015	1 Year
<input checked="" type="checkbox"/>	Three phase impedance network	Teseq/Germany	INA2197/37A	1305A02873	N/A	N/A
<input checked="" type="checkbox"/>	Three phase impedance network	Teseq/Germany	INA 2196/75A	1305A02874	N/A	N/A
<input type="checkbox"/>	Proflin 2100 AC Switching Unit	Teseq/Germany	NSG2200-3	A22714	N/A	N/A

3.4. For Electrostatic Discharge Immunity Test

Used	Equipment	Manufacturer	Model No.	Serial No.	Last Cal.	Cal. Interval
<input checked="" type="checkbox"/>	ESD Tester	TESEQ AG	NSG 438A	130	May 16, 2015	1 Year
<input checked="" type="checkbox"/>	Impulse Module	TESEQ AG	INA 4380-150pF/330Ohm	403-550/1712	May 16, 2015	1 Year

3.5. For RF Strength Susceptibility Test

Used	Equipment	Manufacturer	Model No.	Serial No.	Last Cal.	Cal. Interval
<input checked="" type="checkbox"/>	RF Power Meter. Dual Channel	BOONTON	4232A	10539	May 16, 2015	1 Year
<input checked="" type="checkbox"/>	50ohm Diode Power Sensor	BOONTON	51011EMC	34236/34238	May 16, 2015	1 Year
<input type="checkbox"/>	Broad-Band Horn Antenna	SCHWARZBECK	BBHA 9120 L3F	332	May 16, 2015	1 Year
<input checked="" type="checkbox"/>	Power Amplifier	PRANA	AP32MT215	N/A	May 16, 2015	1 Year
<input type="checkbox"/>	Power Amplifier	MILMEGA	AS0102-55	N/A	May 16, 2015	1 Year
<input checked="" type="checkbox"/>	Signal Generator	AEROFLEX	2023B	N/A	May 16, 2015	1 Year
<input checked="" type="checkbox"/>	Field Strength Meter	HOLADAY	HI-6005	N/A	May 16, 2015	1 Year
<input checked="" type="checkbox"/>	RS232 Fiber Optic Modem	HOLADAY	HI-4413P	N/A	May 16, 2015	1 Year
<input checked="" type="checkbox"/>	Log.-Per. Antenna	SCHWARZBECK	VULP 9118E	N/A	May 16, 2015	1 Year

3.6. For Electrical Fast Transient /Burst Immunity Test

Used	Equipment	Manufacturer	Model No.	Serial No.	Last Cal.	Cal. Interval
<input checked="" type="checkbox"/>	Burst Tester	HAEFELY	PEFT4010	080981-16	May 16, 2015	1Year
<input checked="" type="checkbox"/>	Coupling Clamp	HAEFELY	IP-4A	147147	May 16, 2015	1Year
<input checked="" type="checkbox"/>	Three phase CDN	Teseq	CDN 163	202	May 16, 2015	1 Year

3.7. For Surge Immunity Test

Used	Equipment	Manufacturer	Model No.	Serial No.	Last Cal.	Cal. Interval
<input checked="" type="checkbox"/>	Surge Controller	HAEFELY	Psurge 8000	174031	May 16, 2015	1Year
<input checked="" type="checkbox"/>	Impulse Module	HAEFELY	PIM 100	174124	May 16, 2015	1Year
<input checked="" type="checkbox"/>	Coupling Decoupling Filter	HAEFELY	PCD 130	172181	May 16, 2015	1Year

3.8. For Injected Current Susceptibility Test

Used	Equipment	Manufacturer	Model No.	Serial No.	Last Cal.	Cal. Interval
<input checked="" type="checkbox"/>	Simulator	EMTEST	CWS500C	0900-12	May 16, 2015	1Year
<input type="checkbox"/>	CDN	EMTEST	CDN-M2	5100100100	May 16, 2015	1Year
<input type="checkbox"/>	CDN	EMTEST	CDN-M3	0900-11	May 16, 2015	1Year
<input checked="" type="checkbox"/>	Injection Clamp	EMTEST	F-2031-23MM	368	May 16, 2015	1Year
<input checked="" type="checkbox"/>	Attenuator	EMTEST	ATT6	0010222A	May 16, 2015	1Year
<input type="checkbox"/>	Three phase CDN	Teseq	CDN M332S	32655	May 16, 2015	1 Year
<input type="checkbox"/>	Three phase CDN	Teseq	CDN M432S	33670	May 16, 2015	1 Year
<input type="checkbox"/>	Three phase CDN	Teseq	CDN M432-3LNS	34048	May 16, 2015	1 Year
<input checked="" type="checkbox"/>	Three phase CDN	Teseq	CDN M532S	33799	May 16, 2015	1 Year

3.9. For Magnetic Field Immunity Test

Used	Equipment	Manufacturer	Model No.	Serial No.	Last Cal.	Cal. Interval
<input checked="" type="checkbox"/>	Magnetic Field Tester	HAEFELY	MAG100	250040.1	May 16, 2015	1Year

3.10. Low Frequency Signals Test

Used	Equipment	Manufacturer	Model No.	Serial No.	Last Cal.	Cal. Interval
<input checked="" type="checkbox"/>	Programmable AC Source	CHROMA	6530	/	May 16, 2015	1Year

4. CONDUCTED EMISSION MEASUREMENT

4.1. Block Diagram of Test Setup

For AC Mains:

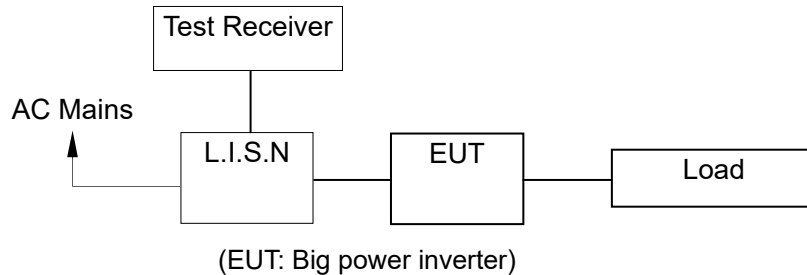

4.2. Measuring Standard

EN62040-2: 2006, IEC 62040-2:2005 Category C2
Power Line Conducted Emission Limits

Frequency (MHz)	Limit (dB μ V)	
	Quasi-peak Level	Average Level
0.15 ~ 0.50	79	66
0.50 ~ 5.0	73	60
5.0 ~ 30.00	73	60

NOTE1- The lower limit shall apply at the transition frequencies.
NOTE2- An allowance of +14 dB is permitted for conducted disturbances.

4.3. EUT Configuration on Measurement

The following equipments are installed on Conducted Emission Measurement to meet EN 62040-2 requirements and operating in a manner which tends to maximize its emission characteristics in a normal application.

Big power inverter (EUT)
 Model Number : APS-3048SW-LCD, APS-5048SW-LCD
 Serial Number : N/A

4.4. Operating Condition of EUT

- 4.4.1. Setup the EUT as shown on Section 4.1.
- 4.4.2. Turn on the power of all equipments.
- 4.4.3. Let the EUT work in measuring mode (Line mode, Battery mode) and measure it.

4.5. Test Procedure

The EUT and External Battery are put on the plane 12mm high above the ground by insulating support and connected to the AC mains through Line Impedance Stability Network (L.I.S.N) or connected to the telecommunication port through an impedance stabilization network (ISN). L.I.S.N provided a 50ohm coupling impedance for the tested equipments AC mains port, I.S.N provided a common mode (asymmetric mode) impedance of 150 Ω to the telecommunication port under test. Both sides of AC line and telecommunication line are investigated to find out the maximum conducted emission according to the EN 62040-2 regulations during conducted emission measurement.

The bandwidth of the field strength meter (R&S Test Receiver ESCS30) is set at 9KHz in 150KHz~30MHz and 200Hz in 9KHz~150KHz.

The frequency range from 150kHz to 30MHz is investigated

4.6. Measuring Results

PASS.

Please refer to the following pages.

APS-3048SW-LCD:



Site Conduction #2

Phase: **L1**

Temperature: 26

Limit: (CE)EN62040-2 C2_QP

Power: AC 230V/50Hz

Humidity: 55 %

Mode: LINE MODE

Note:

No.	Mk.	Freq. MHz	Reading Level dBuV	Correct Factor dB	Measure- ment dBuV	Limit dBuV	Over dB	Detector	Comment
1		0.1550	69.30	0.00	69.30	79.00	-9.70	QP	
2	*	0.1550	62.78	0.00	62.78	66.00	-3.22	AVG	
3		0.3050	63.42	0.00	63.42	79.00	-15.58	QP	
4		0.3050	58.17	0.00	58.17	66.00	-7.83	AVG	
5		0.4600	60.42	0.00	60.42	79.00	-18.58	QP	
6		0.4600	54.32	0.00	54.32	66.00	-11.68	AVG	
7		0.9200	57.52	0.00	57.52	73.00	-15.48	QP	
8		0.9200	51.99	0.00	51.99	60.00	-8.01	AVG	
9		3.3000	59.47	0.00	59.47	73.00	-13.53	QP	
10		3.3000	49.17	0.00	49.17	60.00	-10.83	AVG	
11		9.6200	59.88	0.00	59.88	73.00	-13.12	QP	
12		9.6200	51.02	0.00	51.02	60.00	-8.98	AVG	

*:Maximum data x:Over limit !:over margin Comment: Factor build in receiver. Operator:

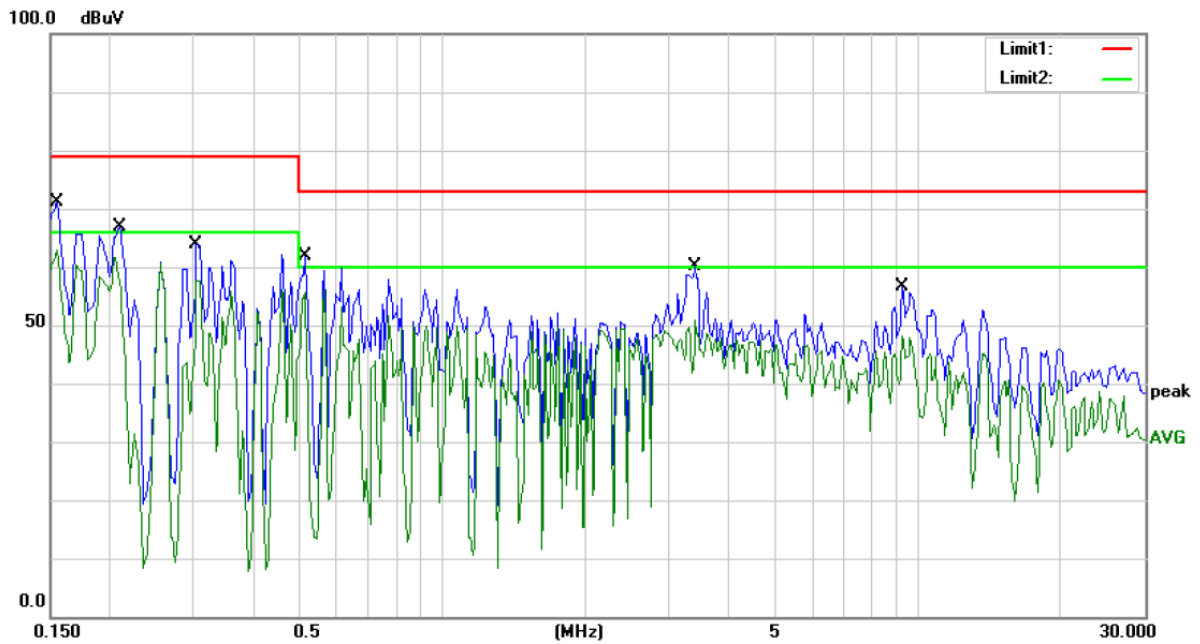

Site Conduction #2

Phase: **N**

Temperature: 26

Limit: (CE)EN62040-2 C2_QP

Power: AC 230V/50Hz

Humidity: 55 %

Mode: LINE MODE

Note:

No.	Mk.	Freq. MHz	Reading Level dBuV	Correct Factor dB	Measure- ment dBuV	Limit dBuV	Over dB	Detector	Comment
1		0.1550	71.07	0.00	71.07	79.00	-7.93	QP	
2	*	0.1550	62.87	0.00	62.87	66.00	-3.13	AVG	
3		0.2100	66.95	0.00	66.95	79.00	-12.05	QP	
4		0.2100	62.11	0.00	62.11	66.00	-3.89	AVG	
5		0.3050	64.00	0.00	64.00	79.00	-15.00	QP	
6		0.3050	57.66	0.00	57.66	66.00	-8.34	AVG	
7		0.5150	61.82	0.00	61.82	73.00	-11.18	QP	
8		0.5150	55.61	0.00	55.61	60.00	-4.39	AVG	
9		3.4000	60.25	0.00	60.25	73.00	-12.75	QP	
10		3.4000	51.00	0.00	51.00	60.00	-9.00	AVG	
11		9.2900	56.51	0.00	56.51	73.00	-16.49	QP	
12		9.2900	48.11	0.00	48.11	60.00	-11.89	AVG	

*:Maximum data x:Over limit !:over margin Comment: Factor build in receiver. Operator:

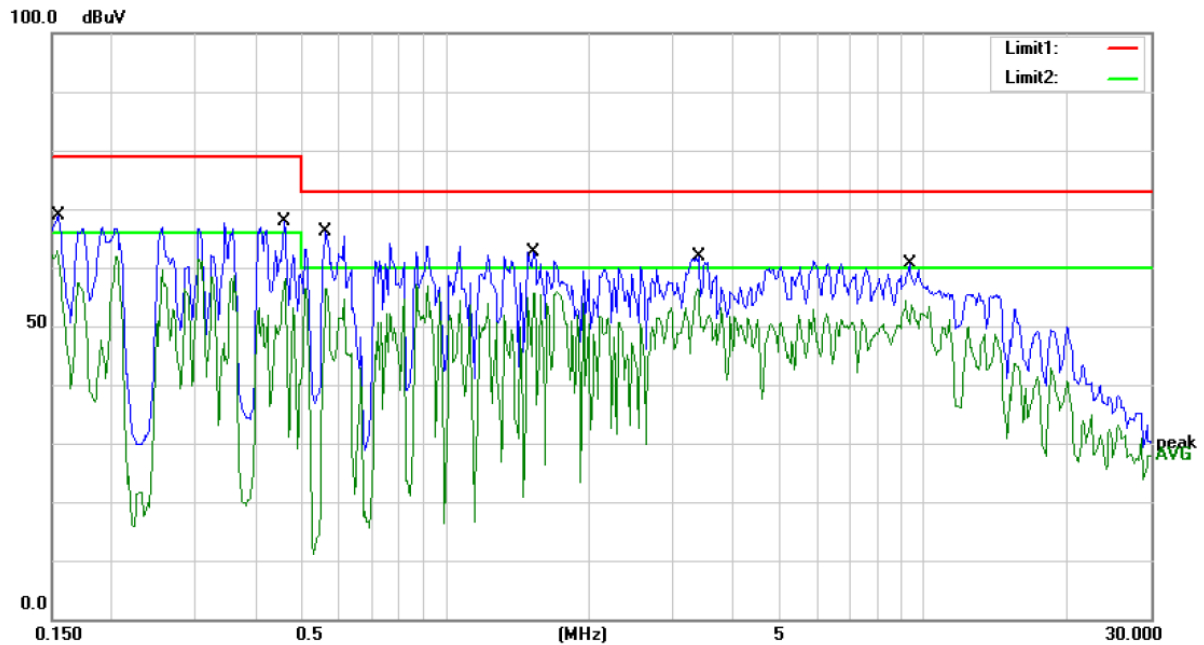

Site Conduction #2

Phase: **L1**

Temperature: 26

Limit: (CE)EN62040-2 C2_QP

Power: DC 48V

Humidity: 55 %

Mode: BAT MODE

Note:

No. Mk.	Freq. MHz	Reading Level dBuV	Correct Factor dB	Measure- ment dBuV	Limit dBuV	Over dB	Detector	Comment
1	0.1550	68.90	0.00	68.90	79.00	-10.10	QP	
2 *	0.1550	62.95	0.00	62.95	66.00	-3.05	AVG	
3	0.4600	67.86	0.00	67.86	79.00	-11.14	QP	
4	0.4600	59.00	0.00	59.00	66.00	-7.00	AVG	
5	0.5600	66.25	0.00	66.25	73.00	-6.75	QP	
6	0.5600	56.49	0.00	56.49	60.00	-3.51	AVG	
7	1.5350	62.70	0.00	62.70	73.00	-10.30	QP	
8	1.5350	55.67	0.00	55.67	60.00	-4.33	AVG	
9	3.3814	61.82	0.00	61.82	73.00	-11.18	QP	
10	3.3814	56.35	0.00	56.35	60.00	-3.65	AVG	
11	9.3700	60.62	0.00	60.62	73.00	-12.38	QP	
12	9.3700	54.45	0.00	54.45	60.00	-5.55	AVG	

*:Maximum data x:Over limit !:over margin Comment: Factor build in receiver. Operator:

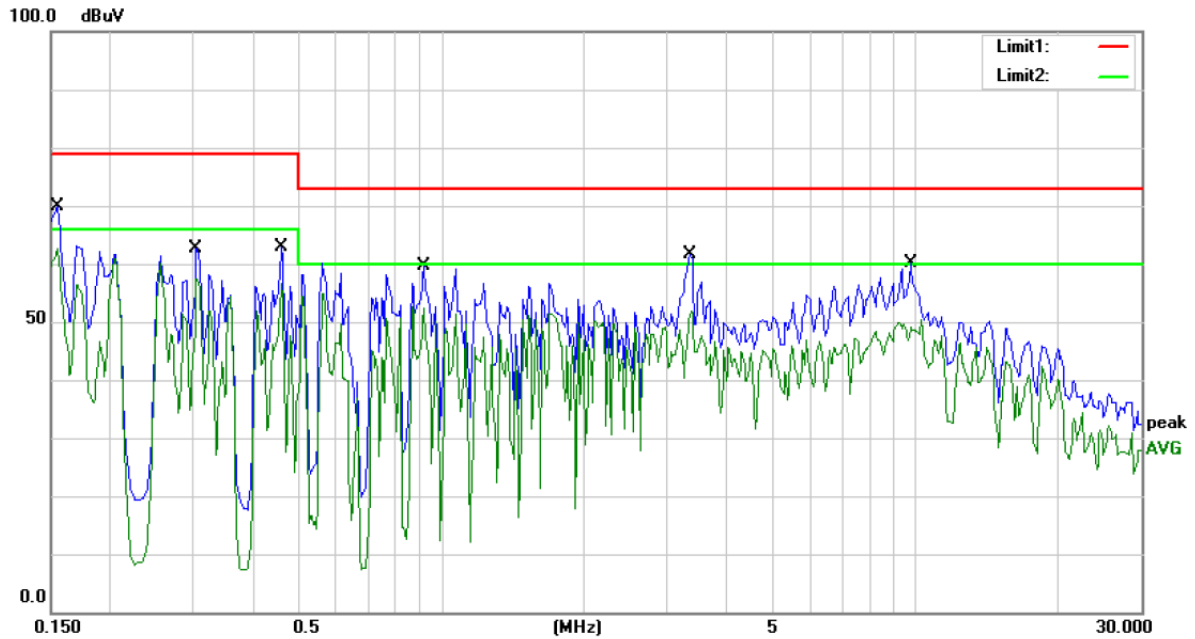

Site Conduction #2

Phase: **N**

Temperature: 26

Limit: (CE)EN62040-2 C2_QP

Power: DC 48V

Humidity: 55 %

Mode: BAT MODE

Note:

No.	Mk.	Freq.	Reading Level	Correct Factor	Measurement	Limit	Over	Detector	Comment
		MHz	dBuV	dB	dBuV	dBuV	dB		
1		0.1550	69.90	0.00	69.90	79.00	-9.10	QP	
2	*	0.1550	62.52	0.00	62.52	66.00	-3.48	AVG	
3		0.3050	62.63	0.00	62.63	79.00	-16.37	QP	
4		0.3050	60.25	0.00	60.25	66.00	-5.75	AVG	
5		0.4600	62.86	0.00	62.86	79.00	-16.14	QP	
6		0.4600	57.01	0.00	57.01	66.00	-8.99	AVG	
7		0.9200	59.58	0.00	59.58	73.00	-13.42	QP	
8		0.9200	52.69	0.00	52.69	60.00	-7.31	AVG	
9		3.3456	61.74	0.00	61.74	73.00	-11.26	QP	
10		3.3456	51.85	0.00	51.85	60.00	-8.15	AVG	
11		9.7900	60.04	0.00	60.04	73.00	-12.96	QP	
12		9.7900	50.42	0.00	50.42	60.00	-9.58	AVG	

*:Maximum data x:Over limit !:over margin Comment: Factor build in receiver. Operator:

APS-5048SW-LCD:

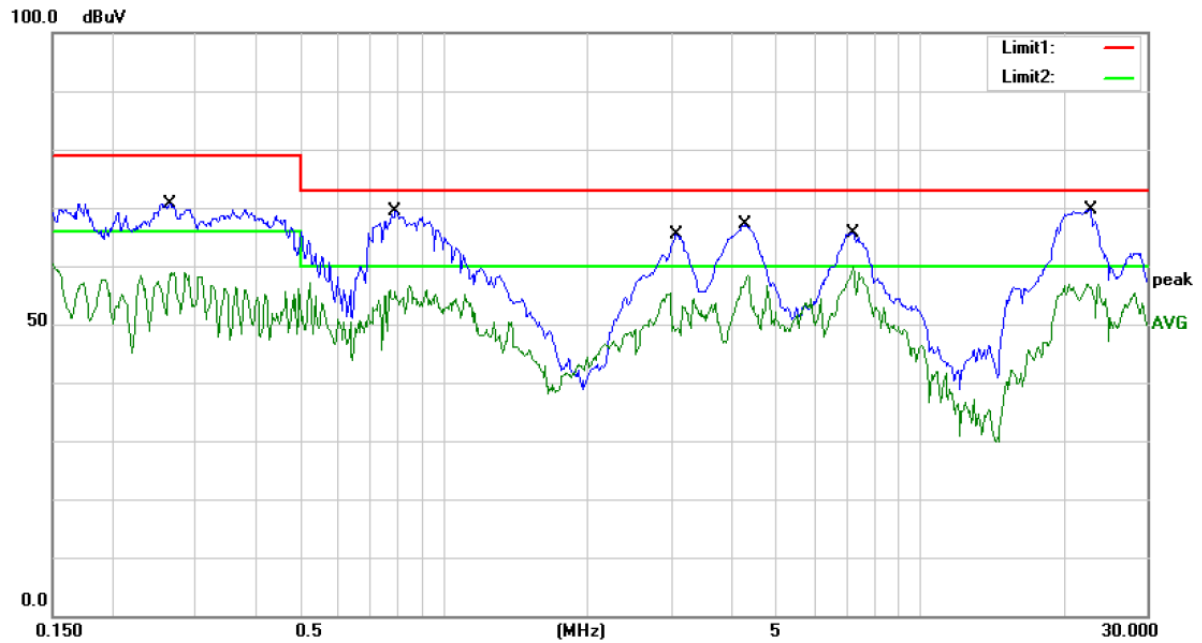

Site Conduction #2

Phase: **L1**

Temperature: 26

Limit: (CE)EN62040-2 C2_QP

Power: AC 230V/50Hz

Humidity: 55 %

Mode: LINE MODE

Note:

No.	Mk.	Freq. MHz	Reading Level dBuV	Correct Factor dB	Measure- ment dBuV	Limit dBuV	Over dB	Detector	Comment
1		0.2644	70.74	0.00	70.74	79.00	-8.26	QP	
2		0.2644	58.99	0.00	58.99	66.00	-7.01	AVG	
3		0.7872	69.29	0.00	69.29	73.00	-3.71	QP	
4		0.7872	56.57	0.00	56.57	60.00	-3.43	AVG	
5		3.0737	65.40	0.00	65.40	73.00	-7.60	QP	
6		3.0737	55.40	0.00	55.40	60.00	-4.60	AVG	
7		4.2918	67.09	0.00	67.09	73.00	-5.91	QP	
8		4.2918	58.48	0.00	58.48	60.00	-1.52	AVG	
9		7.2134	65.71	0.00	65.71	73.00	-7.29	QP	
10	*	7.2134	59.99	0.00	59.99	60.00	-0.01	AVG	
11		22.8963	69.66	0.00	69.66	73.00	-3.34	QP	
12		22.8963	56.90	0.00	56.90	60.00	-3.10	AVG	

*:Maximum data x:Over limit !:over margin Comment: Factor build in receiver. Operator:

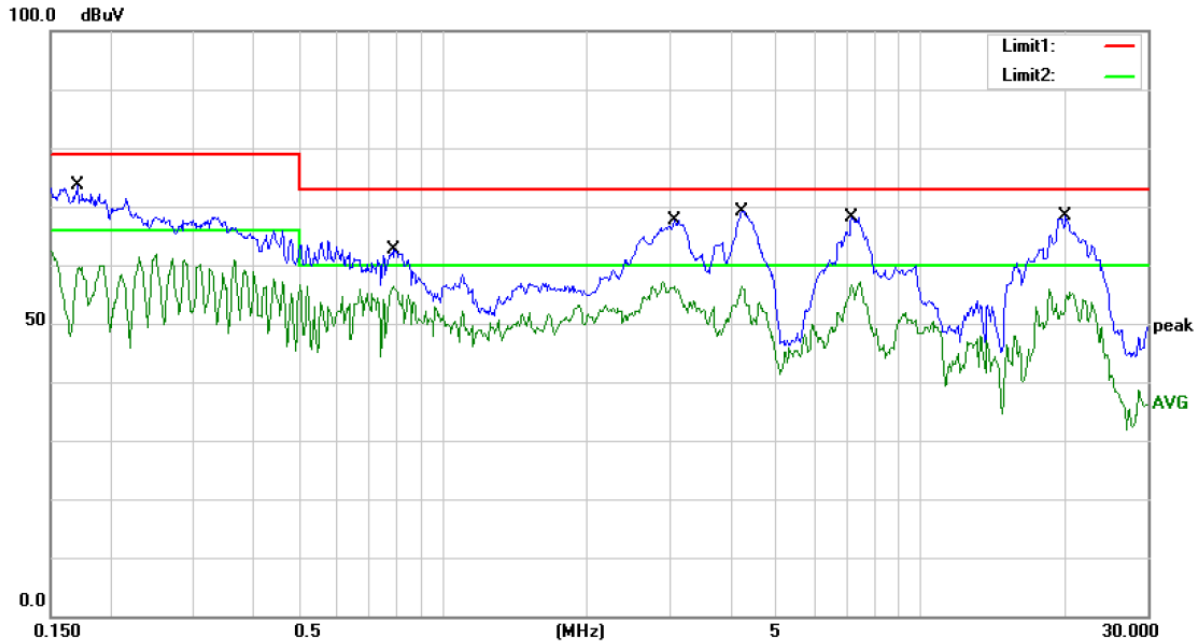

Site Conduction #2 Phase: **N** Temperature: 26
 Limit: (CE)EN62040-2 C2_QP Power: AC 230V/50Hz Humidity: 55 %
 Mode: LINE MODE
 Note:

No.	Mk.	Freq.	Reading Level	Correct Factor	Measurement	Limit	Over	Detector	Comment
		MHz	dBuV	dB	dBuV	dBuV	dB		
1		0.1711	73.71	0.00	73.71	79.00	-5.29	QP	
2		0.1711	59.53	0.00	59.53	66.00	-6.47	AVG	
3		0.7873	62.62	0.00	62.62	73.00	-10.38	QP	
4		0.7873	56.37	0.00	56.37	60.00	-3.63	AVG	
5		3.0574	67.73	0.00	67.73	73.00	-5.27	QP	
6		3.0574	56.40	0.00	56.40	60.00	-3.60	AVG	
7		4.2240	69.20	0.00	69.20	73.00	-3.80	QP	
8	*	4.2240	56.48	0.00	56.48	60.00	-3.52	AVG	
9		7.1753	68.03	0.00	68.03	73.00	-4.97	QP	
10		7.1753	55.80	0.00	55.80	60.00	-4.20	AVG	
11		20.1623	68.37	0.00	68.37	73.00	-4.63	QP	
12		20.1623	55.35	0.00	55.35	60.00	-4.65	AVG	

*:Maximum data x:Over limit !:over margin Comment: Factor build in receiver. Operator:

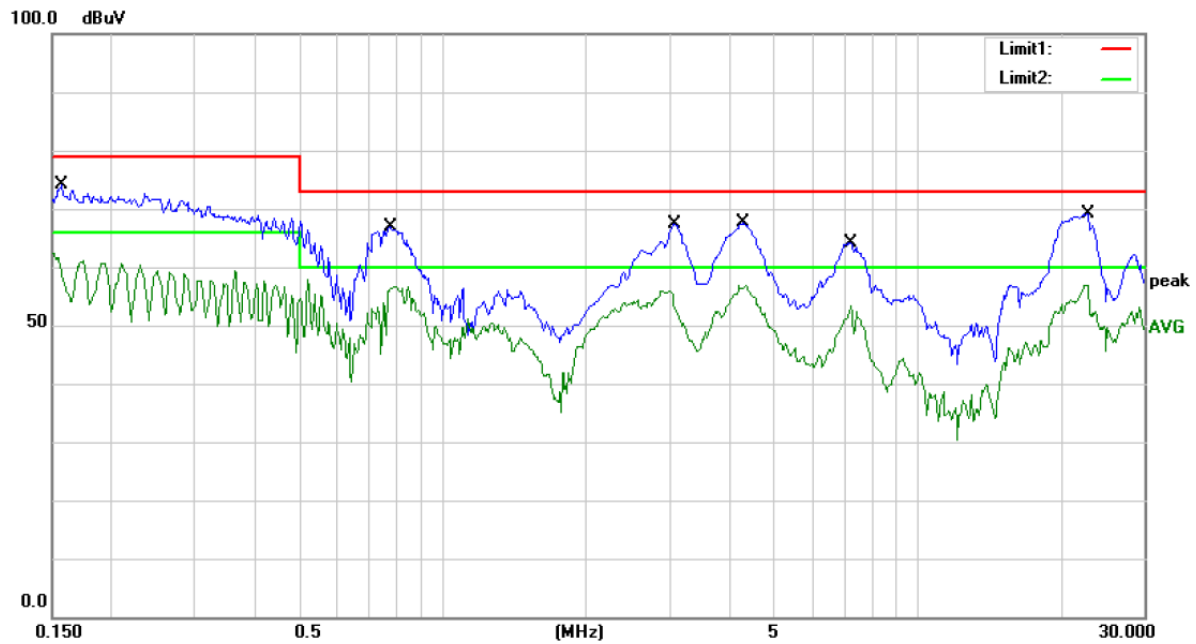

Site Conduction #2

Phase: **L1**

Temperature: 26

Limit: (CE)EN62040-2 C2_QP

Power: DC 48V

Humidity: 55 %

Mode: BAT MODE

Note:

No.	Mk.	Freq.	Reading Level	Correct Factor	Measurement	Limit	Over	Detector	Comment
		MHz	dBuV	dB	dBuV	dBuV	dB		
1		0.1572	74.19	0.00	74.19	79.00	-4.81	QP	
2		0.1572	62.39	0.00	62.39	66.00	-3.61	AVG	
3		0.7751	66.83	0.00	66.83	73.00	-6.17	QP	
4		0.7751	56.74	0.00	56.74	60.00	-3.26	AVG	
5		3.0750	67.40	0.00	67.40	73.00	-5.60	QP	
6		3.0750	55.91	0.00	55.91	60.00	-4.09	AVG	
7		4.3000	67.59	0.00	67.59	73.00	-5.41	QP	
8	*	4.3000	56.98	0.00	56.98	60.00	-3.02	AVG	
9		7.2200	64.21	0.00	64.21	73.00	-8.79	QP	
10		7.2200	53.49	0.00	53.49	60.00	-6.51	AVG	
11		22.9250	69.16	0.00	69.16	73.00	-3.84	QP	
12		22.9250	56.90	0.00	56.90	60.00	-3.10	AVG	

*:Maximum data x:Over limit !:over margin Comment: Factor build in receiver. Operator:

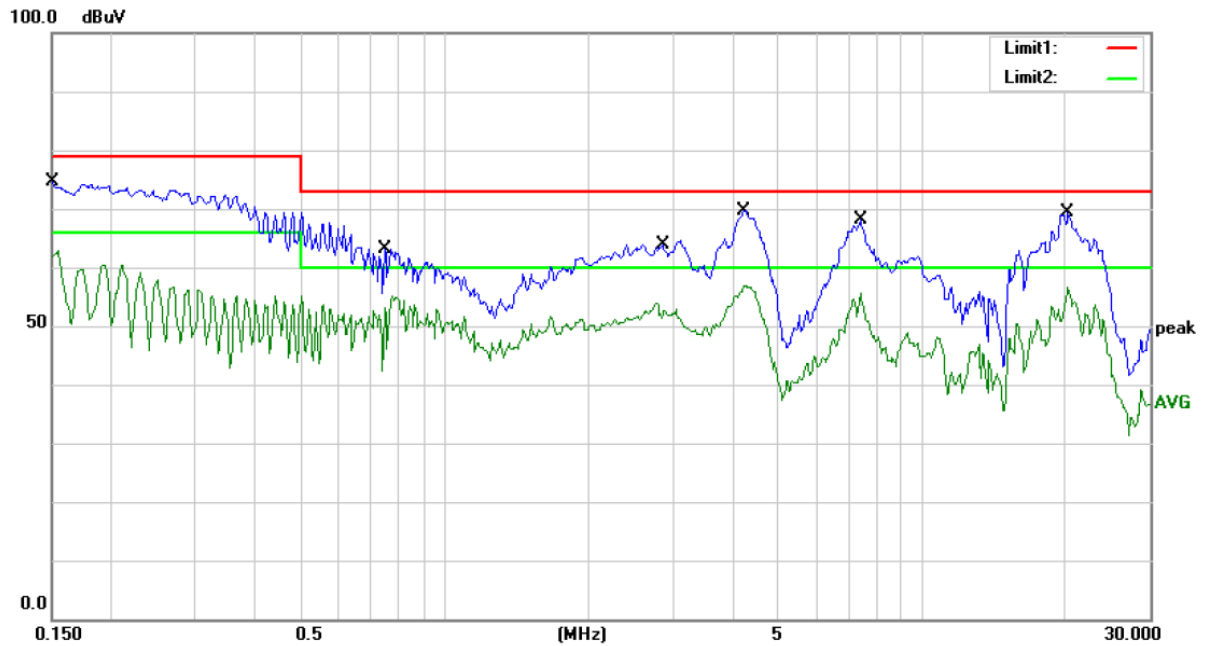

Site Conduction #2

Phase: **N**

Temperature: 26

Limit: (CE)EN62040-2 C2_QP

Power: DC 48V

Humidity: 55 %

Mode: BAT MODE

Note:

No. Mk.	Freq. MHz	Reading Level dBuV	Correct Factor dB	Measure- ment dBuV	Limit dBuV	Over dB	Detector	Comment
1	0.1507	74.71	0.00	74.71	79.00	-4.29	QP	
2	0.1507	62.76	0.00	62.76	66.00	-3.24	AVG	
3	0.7500	63.25	0.00	63.25	73.00	-9.75	QP	
4	0.7500	55.03	0.00	55.03	60.00	-4.97	AVG	
5	2.8600	63.79	0.00	63.79	73.00	-9.21	QP	
6	2.8600	53.93	0.00	53.93	60.00	-6.07	AVG	
7	4.2250	69.70	0.00	69.70	73.00	-3.30	QP	
8 *	4.2250	56.98	0.00	56.98	60.00	-3.02	AVG	
9	7.4100	68.03	0.00	68.03	73.00	-4.97	QP	
10	7.4100	55.70	0.00	55.70	60.00	-4.30	AVG	
11	20.2000	69.37	0.00	69.37	73.00	-3.63	QP	
12	20.2000	56.53	0.00	56.53	60.00	-3.47	AVG	

*:Maximum data x:Over limit !:over margin Comment: Factor build in receiver. Operator:

5. RADIATED EMISSION MEASUREMENT

5.1. Block Diagram of Test

5.1.1. Block diagram of connection between the EUT and simulators

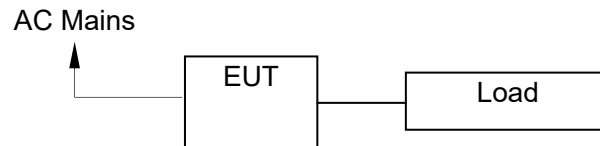

(EUT: Big power inverter)

5.1.2. Block diagram of test setup (In chamber)

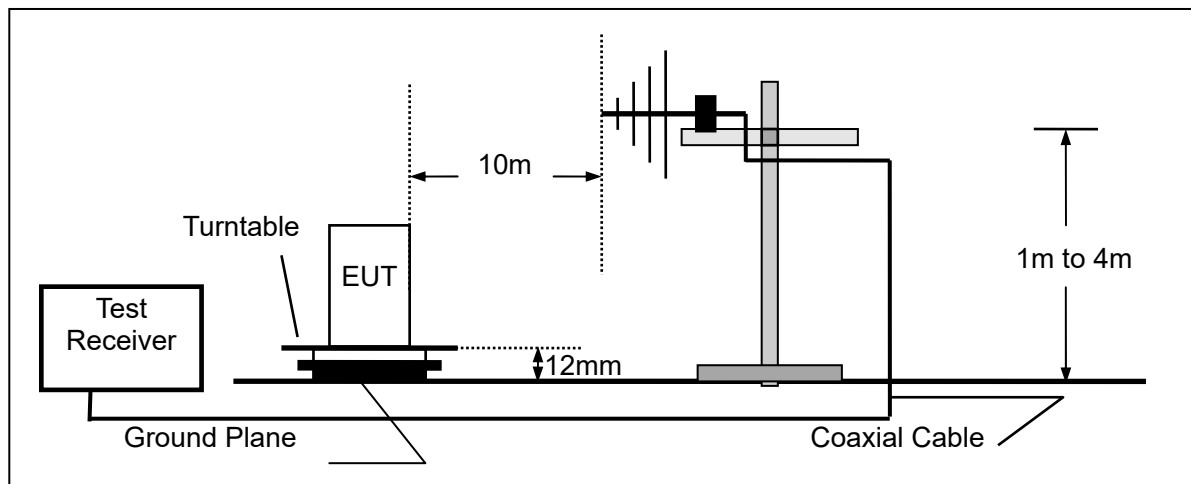

(EUT: Big power inverter)

5.2. Measuring Standard

EN62040-2: 2006 Category C2.

5.3. Radiated Emission Limits

All emanations from device or system, including any network of conductors and apparatus connected thereto, shall not exceed the level of field strengths specified below:

FREQUENCY (MHz)	DISTANCE (Meters)	FIELD STRENGTHS LIMIT (dB μ V/m)
30 ~ 230	10	40
230 ~ 1000	10	47

Note: (1) The smaller limit shall apply at the combination point between two frequency bands.
(2) Distance refers to the distance in meters between the measuring instrument antenna and the closed point of any part of the EUT.

5.4. EUT Configuration on Test

The EN 62040-2 regulations test method must be used to find the maximum emission during radiated emission measurement.

5.5. Operating Condition of EUT

5.5.1. Turn on the power.

5.5.2. After that, let the EUT work in test mode (Line mode, Battery mode) and measure it.

5.6. Test Procedure

The EUT and External Battery are placed on a turn table which is 0.8m high above the ground. The turn table can rotate 360 degrees to determine the position of the maximum emission level. The EUT is set 10 meters away from the receiving antenna which is mounted on an antenna tower. The antenna can be moved up and down from 1 to 4 meters to find out the maximum emission level. Bilog antenna (calibrated by Dipole Antenna) is used as a receiving antenna. Both horizontal and vertical polarization of the antenna is set on test.

The bandwidth of the Receiver is set at 120 kHz.

5.7. Measuring Results

PASS.

The frequency range from 30MHz to 1000MHz is investigated.

APS-3048SW-LCD:

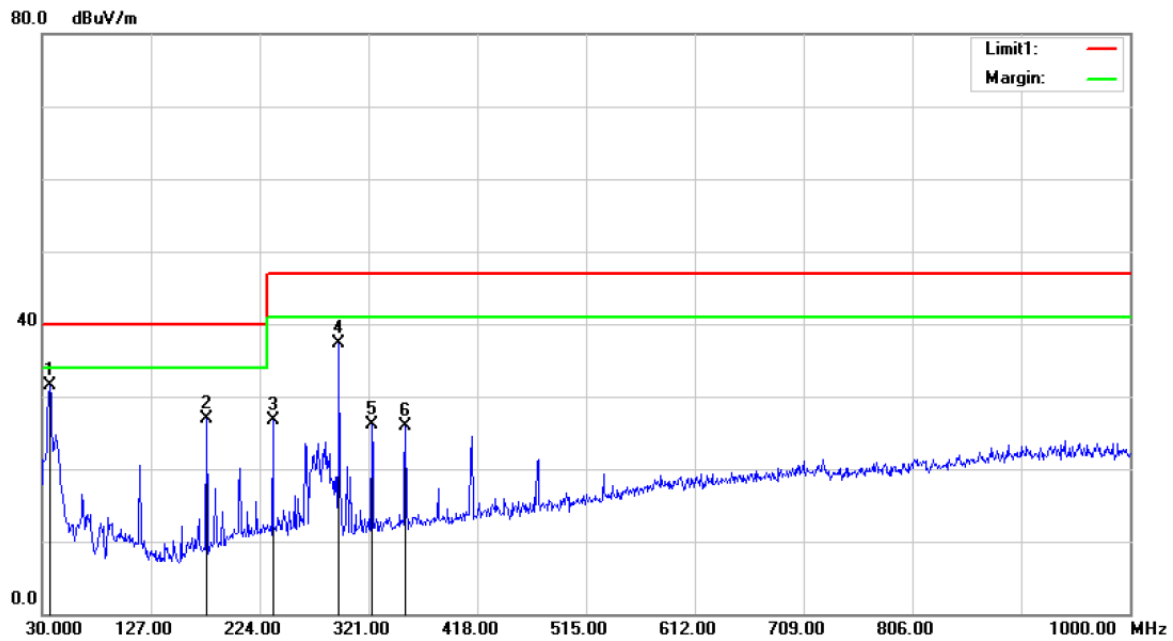

Site :10m Chamber #1 Polarization: *Horizontal* Temperature: 26
 Limit: (RE 10M)EN62040-2 C2 Power: AC 230V/50Hz Humidity: 60 %
 Mode:LINE MODE
 Note:

No.	Mk.	Freq. MHz	Reading Level dBuV	Correct Factor dB	Measure- ment dBuV/m	Limit dBuV/m	Over dB	Detector	Antenna Height cm	Table Degree	Comment
1	*	36.7900	63.90	-32.44	31.46	40.00	-8.54	QP	180	66	
2		176.4700	61.08	-34.25	26.83	40.00	-13.17	QP	180	66	
3		235.6400	57.84	-31.06	26.78	47.00	-20.22	QP	180	299	
4		294.8100	66.89	-29.62	37.27	47.00	-9.73	QP	180	45	
5		323.9100	55.07	-28.95	26.12	47.00	-20.88	QP	180	49	
6		353.9800	54.20	-28.24	25.96	47.00	-21.04	QP	180	351	

*:Maximum data x:Over limit !:over margin

Operator: CSL

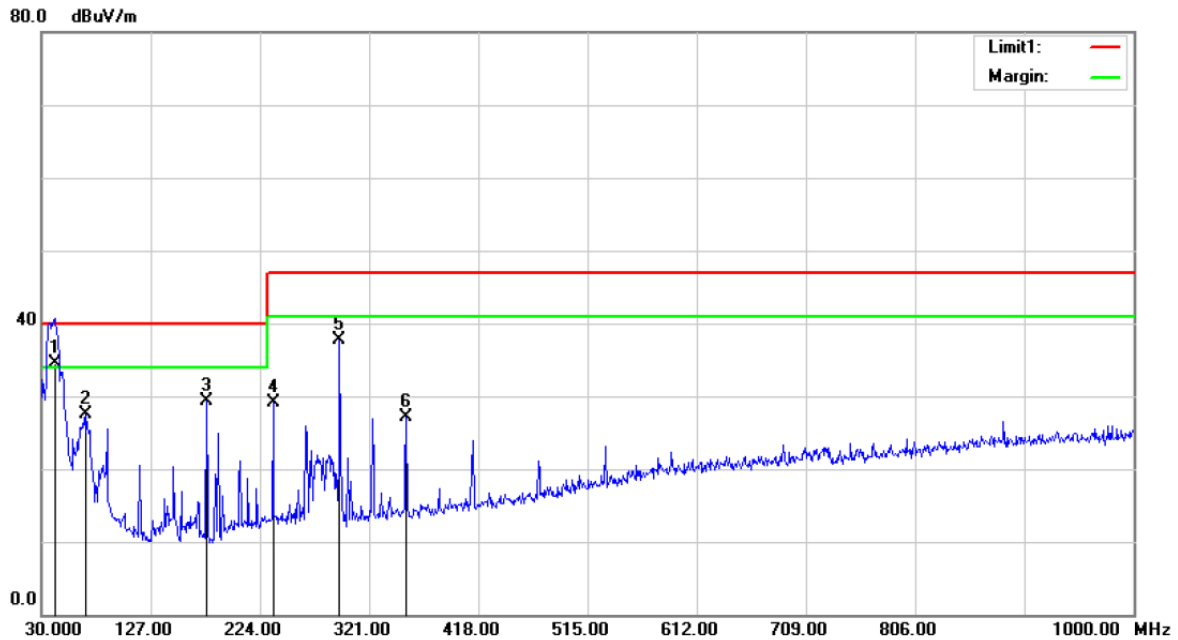

Site :10m Chamber #1 Polarization: *Vertical* Temperature: 26
 Limit: (RE 10M)EN62040-2 C2 Power: AC 230V/50Hz Humidity: 60 %
 Mode:LINE MODE
 Note:

No.	Mk.	Freq. MHz	Reading Level dBuV	Correct Factor dB	Measure- ment dBuV/m	Limit dBuV/m	Over dB	Detector	Antenna Height cm	Table Degree	Comment
1	*	41.6400	65.23	-30.63	34.60	40.00	-5.40	QP	100	351	
2		69.7700	61.23	-33.79	27.44	40.00	-12.56	QP	100	21	
3		176.4700	62.64	-33.32	29.32	40.00	-10.68	QP	100	45	
4		235.6400	59.05	-29.99	29.06	47.00	-17.94	QP	100	103	
5		294.8100	66.17	-28.42	37.75	47.00	-9.25	QP	100	355	
6		353.9800	54.10	-26.92	27.18	47.00	-19.82	QP	100	101	

*:Maximum data x:Over limit !:over margin

Operator: CSL

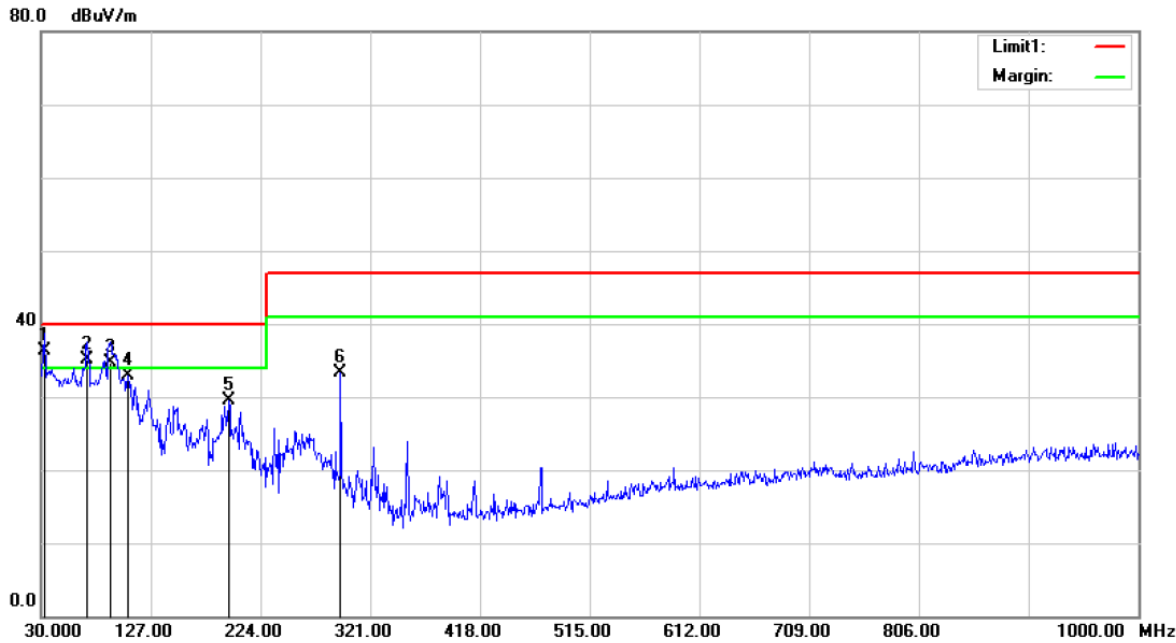

Site :10m Chamber #1

Polarization: *Horizontal*

Temperature: 26

Limit: (RE 10M)EN62040-2 C2

Power: DC 48V

Humidity: 60 %

Mode:BAT MODE

Note:

No.	Mk.	Freq.	Reading Level	Correct Factor	Measurement	Limit	Over	Antenna Height	Table Degree	
		MHz	dBuV	dB	dBuV/m	dBuV/m	dB	cm	degree	Comment
1	*	32.9100	69.45	-33.15	36.30	40.00	-3.70	QP		
2	!	70.7400	69.85	-34.65	35.20	40.00	-4.80	QP		
3	!	91.1100	68.50	-33.80	34.70	40.00	-5.30	QP		
4		106.6300	65.23	-32.38	32.85	40.00	-7.15	QP		
5		195.8700	62.01	-32.47	29.54	40.00	-10.46	QP		
6		294.8100	62.91	-29.62	33.29	47.00	-13.71	QP		

*:Maximum data x:Over limit !:over margin

Operator: CSL

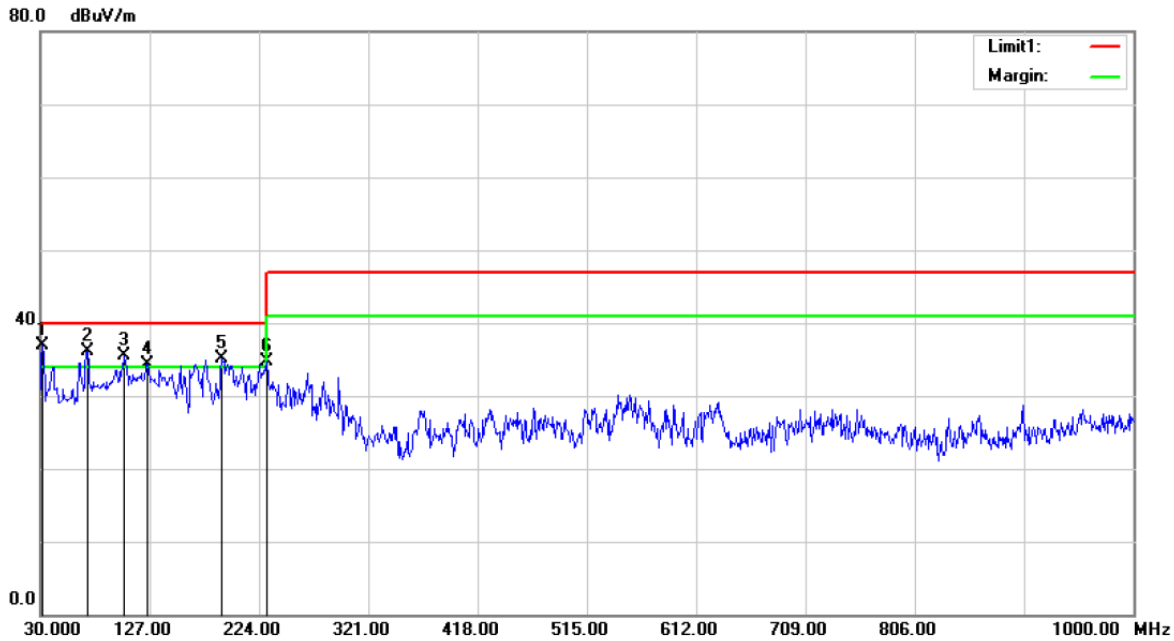

Site :10m Chamber #1 Polarization: **Vertical** Temperature: 26
 Limit: (RE 10M)EN62040-2 C2 Power: DC 48V Humidity: 60 %
 Mode:BAT MODE
 Note:

No.	Mk.	Freq. MHz	Reading Level dBuV	Correct Factor dB	Measure- ment dBuV/m	Limit dBuV/m	Over dB	Antenna Height cm	Table Degree	Comment
1	*	31.9400	69.74	-32.80	36.94	40.00	-3.06	QP		
2	!	71.7100	70.37	-34.21	36.16	40.00	-3.84	QP		
3	!	104.6900	67.16	-31.64	35.52	40.00	-4.48	QP		
4	!	125.0600	68.31	-34.00	34.31	40.00	-5.69	QP		
5	!	191.0200	67.08	-31.98	35.10	40.00	-4.90	QP		
6		230.7900	64.83	-30.13	34.70	47.00	-12.30	QP		

*:Maximum data x:Over limit !:over margin

Operator: CSL

APS-5048SW-LCD:

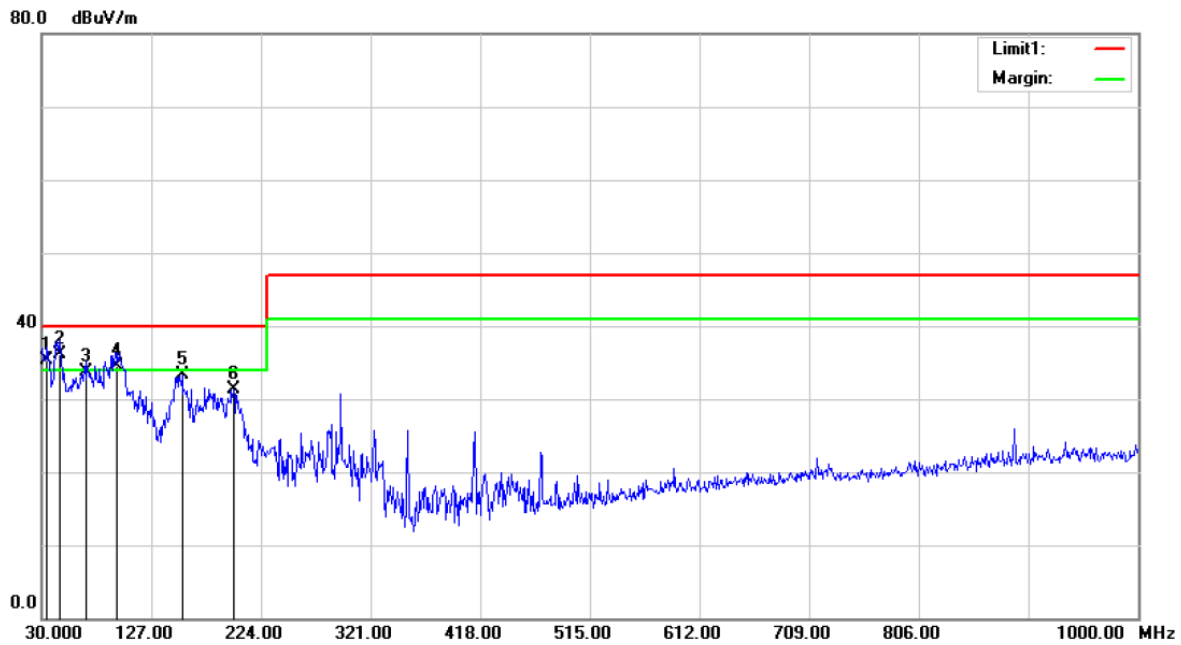

Site :10m Chamber #1

Polarization: *Horizontal*

Temperature: 26

Limit: (RE 10M)EN62040-2 C2

Power: AC 230V/50Hz

Humidity: 60 %

Mode:LINE MODE

Note:

No.	Mk.	Freq. MHz	Reading Level dBuV	Correct Factor dB	Measure- ment dBuV/m	Limit dBuV/m	Over dB	Detector	Antenna Height cm	Table Degree degree	Comment
1	!	34.8500	68.34	-33.04	35.30	40.00	-4.70	QP			
2	*	45.5200	66.63	-30.43	36.20	40.00	-3.80	QP			
3		68.8000	68.00	-34.20	33.80	40.00	-6.20	QP			
4	!	95.9600	67.61	-33.01	34.60	40.00	-5.40	QP			
5		154.1600	68.70	-35.41	33.29	40.00	-6.71	QP			
6		199.7500	63.31	-32.08	31.23	40.00	-8.77	QP			

*:Maximum data x:Over limit !:over margin

Operator: CSL

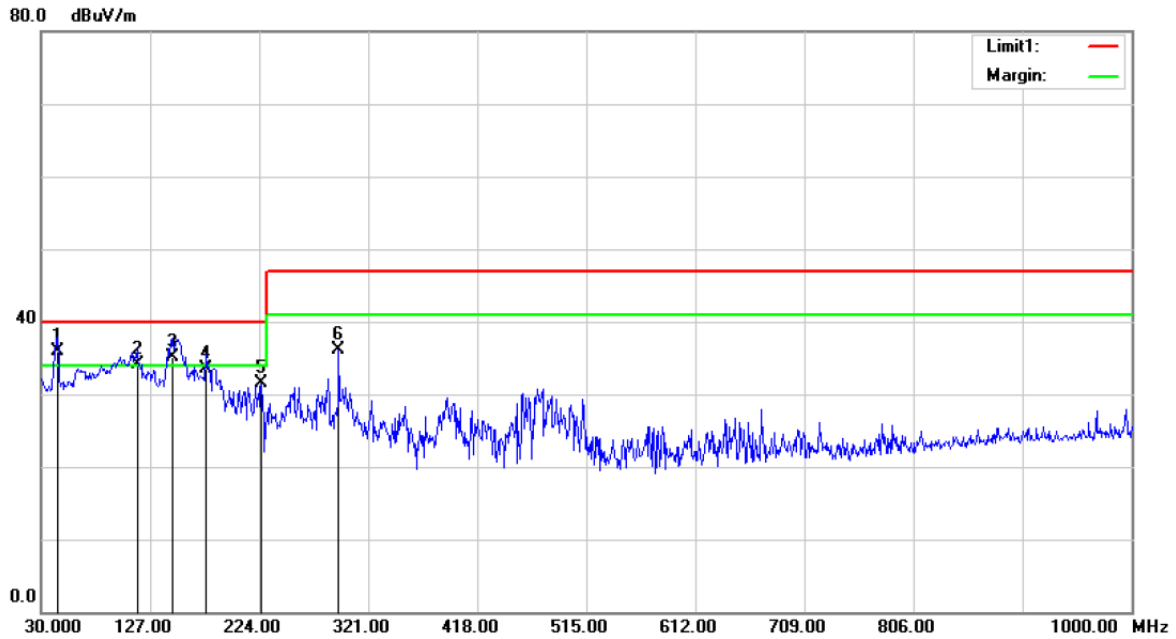

Site :10m Chamber #1 Polarization: **Vertical** Temperature: 26
 Limit: (RE 10M)EN62040-2 C2 Power: AC 230V/50Hz Humidity: 60 %
 Mode:LINE MODE
 Note:

No.	Mk.	Freq.	Reading	Correct	Measurement	Limit	Over	Antenna	Table	
		MHz	dBuV	Factor	dBuV/m	dBuV/m	dB	Height	Degree	Comment
1	*	44.5500	66.07	-30.07	36.00	40.00	-4.00	QP		
2	!	115.3600	66.73	-32.53	34.20	40.00	-5.80	QP		
3	!	146.4000	69.97	-34.87	35.10	40.00	-4.90	QP		
4		176.4700	66.82	-33.32	33.50	40.00	-6.50	QP		
5		225.9400	61.79	-30.29	31.50	40.00	-8.50	QP		
6		294.8100	64.50	-28.42	36.08	47.00	-10.92	QP		

*:Maximum data x:Over limit !:over margin

Operator: CSL

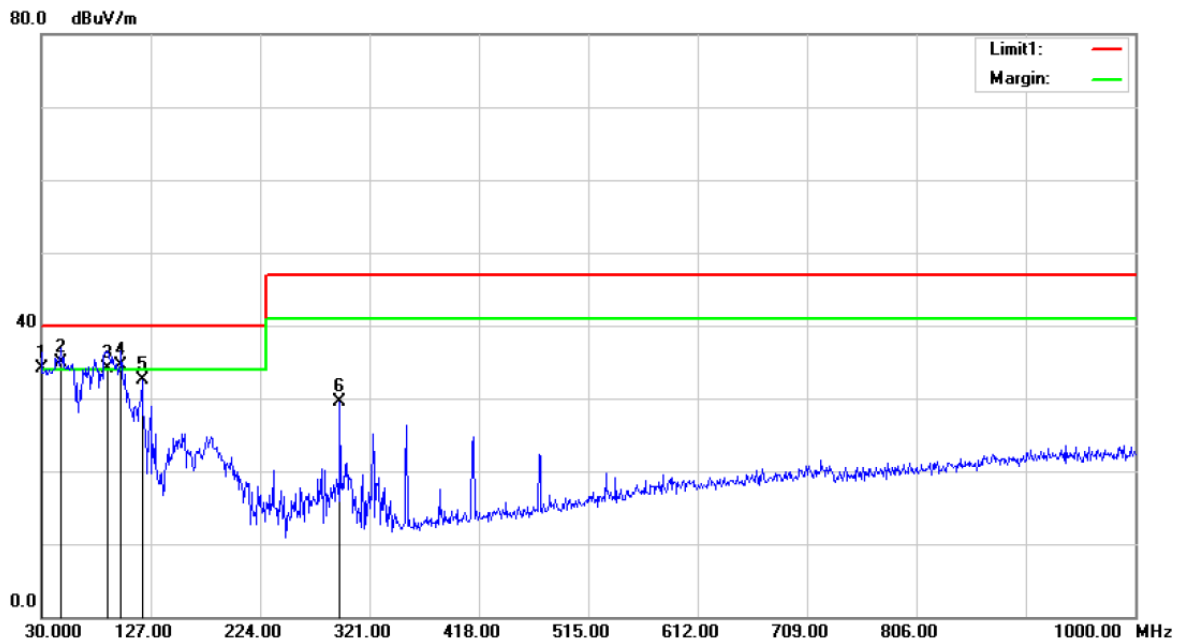

Site :10m Chamber #1

Polarization: *Horizontal*

Temperature: 26

Limit: (RE 10M)EN62040-2 C2

Power: DC 48V

Humidity: 60 %

Mode:BAT MODE

Note:

No.	Mk.	Freq.	Reading Level	Correct Factor	Measurement	Limit	Over	Antenna Height	Table Degree	
		MHz	dBuV	dB	dBuV/m	dBuV/m	dB	cm	degree	Comment
1	!	30.0000	67.42	-33.32	34.10	40.00	-5.90	QP		
2	*	47.4600	65.42	-30.42	35.00	40.00	-5.00	QP		
3	!	88.2000	68.62	-34.42	34.20	40.00	-5.80	QP		
4	!	100.8100	66.84	-32.34	34.50	40.00	-5.50	QP		
5		119.2400	66.41	-33.93	32.48	40.00	-7.52	QP		
6		294.8100	59.16	-29.62	29.54	47.00	-17.46	QP		

*:Maximum data x:Over limit !:over margin

Operator: CSL

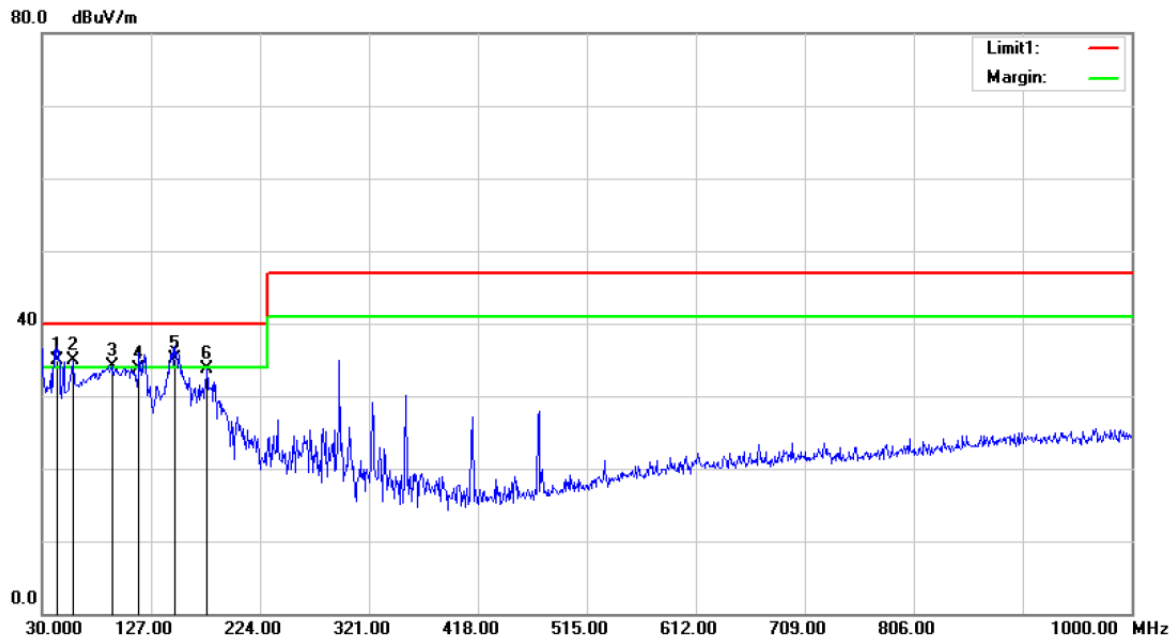

Site :10m Chamber #1

Polarization: *Vertical*

Temperature: 26

Limit: (RE 10M)EN62040-2 C2

Power: DC 48V

Humidity: 60 %

Mode:BAT MODE

Note:

No.	Mk.	Freq.	Reading Level	Correct Factor	Measurement	Limit	Over	Antenna Height	Table Degree	
		MHz	dBuV	dB	dBuV/m	dBuV/m	dB	cm	degree	Comment
1	!	43.5800	65.16	-30.26	34.90	40.00	-5.10	QP		
2	!	57.1600	64.43	-29.53	34.90	40.00	-5.10	QP		
3	!	92.0800	67.14	-32.97	34.17	40.00	-5.83	QP		
4		116.3300	66.39	-32.69	33.70	40.00	-6.30	QP		
5	*	148.3400	69.98	-34.78	35.20	40.00	-4.80	QP		
6		176.4700	67.02	-33.32	33.70	40.00	-6.30	QP		

*:Maximum data x:Over limit !:over margin

Operator: CSL

6. HARMONIC CURRENT EMISSION MEASUREMENT

6.1. Block Diagram of Test Setup

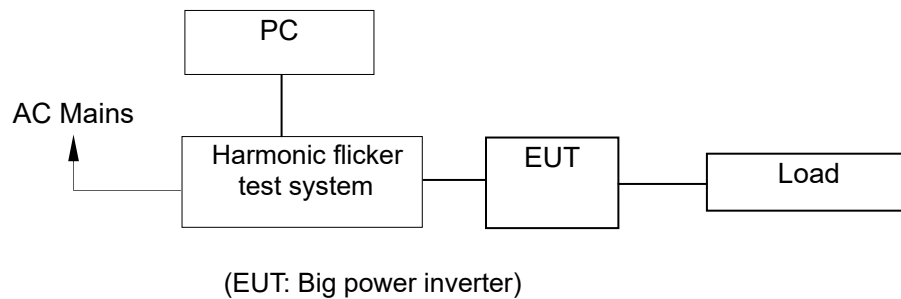

6.2. Measuring Standard

EN 61000-3-12:2011 CLASS A

6.3. Operation Condition of EUT

6.3.1. Setup the EUT as shown on Section 6.1.

6.3.2. Turn on the power of all equipments.

6.3.3. Let the EUT work in measuring mode (Line Mode) and measure it.

6.4. Measuring Results

Please refer to the following pages.

Harmonics – Class-A per Ed. 4.0 (2014)(Run time) incl. inter-harmonics

EUT: UPS (APS-3048SW-LCD)

Tested by: SZW

Test category: Class-A per Ed. 4.0 (2014) (European limits)

Test Margin: 100

Test date: 2015/6/13

Start time: 18:52:12

End time: 18:55:04

Test duration (min): 2.5

Data file name: WIN2105_H-000454.cts_data

Comment: Line Mode

Customer: SANTAK

Test Result: Pass

Source qualification: Normal

Current & voltage waveforms

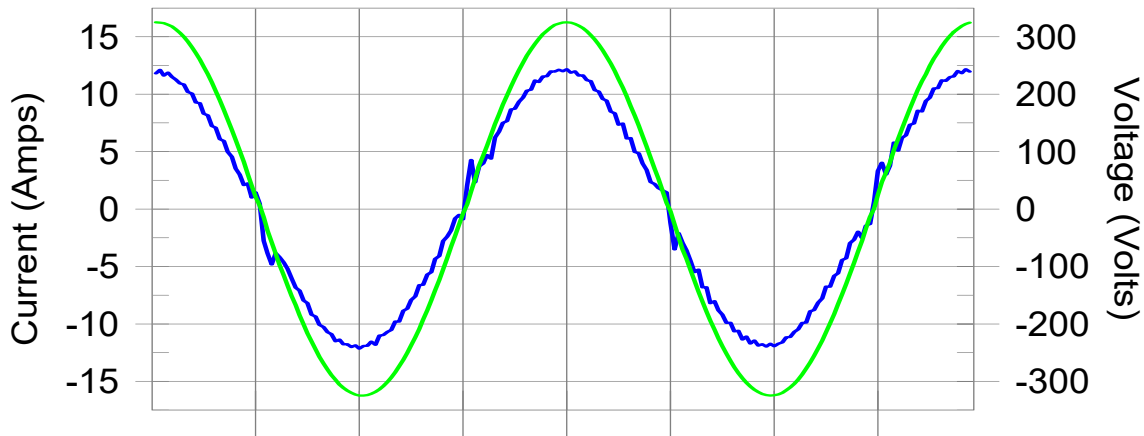

Harmonics and Class A limit line

European Limits

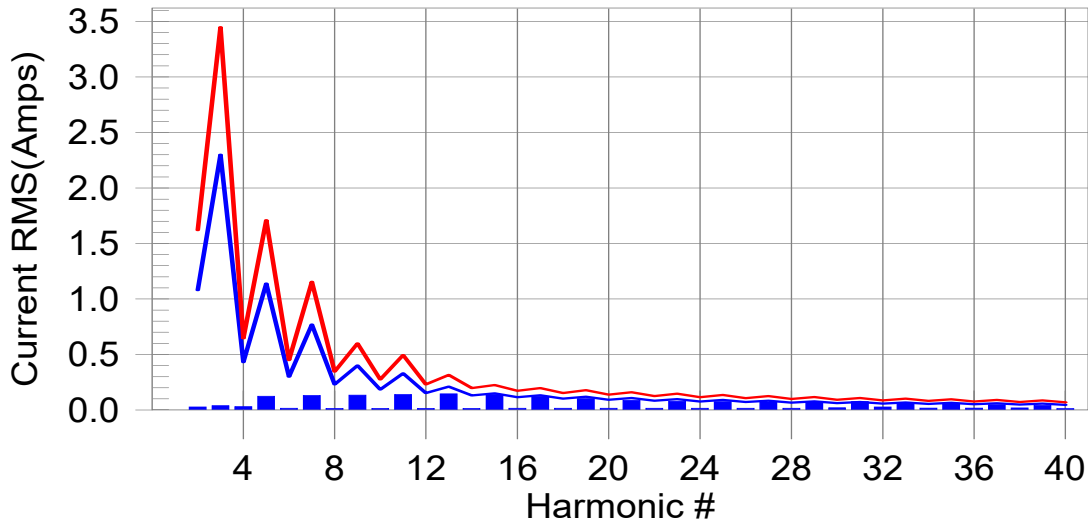

Test result: Pass Worst harmonic was #31 with 99.7% of the limit.

Current Test Result Summary (Run time)

EUT: UPS (APS-3048SW-LCD) Tested by: SZW
 Test category: Class-A per Ed. 4.0 (2014) (European limits) Test Margin: 100
 Test date: 2015/6/13 Start time: 18:52:12 End time: 18:55:04
 Test duration (min): 2.5 Data file name: WIN2105_H-000454.cts_data
 Comment: Line Mode
 Customer: SANTAK

Test Result: Pass Source qualification: Normal
 THC: 0.436 A I-THD: 5.2 % POHC(A): 0.217 A POHC Limit(A): 0.251 A

Highest parameter values during test:

V_RMS (Volts): 229.944	Frequency(Hz): 50.00
I_Peak (Amps): 15.585	I_RMS (Amps): 11.463
I_Fund (Amps): 11.448	Crest Factor: 1.487
Power (Watts): 2538.3	Power Factor: 0.996

Harm#	Harms(avg)	100%Limit	%of Limit	Harms(max)	150%Limit	%of Limit	Status
2	0.026	1.080	2.4	0.032	1.620	2.0	Pass
3	0.038	2.300	1.7	0.044	3.450	1.3	Pass
4	0.030	0.430	7.1	0.033	0.645	5.1	Pass
5	0.124	1.140	10.8	0.126	1.710	7.3	Pass
6	0.015	0.300	5.0	0.017	0.450	3.9	Pass
7	0.130	0.770	16.9	0.132	1.155	11.5	Pass
8	0.014	0.230	5.9	0.016	0.345	4.6	Pass
9	0.133	0.400	33.3	0.139	0.600	23.1	Pass
10	0.014	0.184	7.7	0.017	0.276	6.1	Pass
11	0.140	0.330	42.3	0.144	0.495	29.2	Pass
12	0.014	0.153	9.2	0.017	0.230	7.3	Pass
13	0.146	0.210	69.3	0.150	0.315	47.7	Pass
14	0.014	0.131	10.8	0.016	0.197	8.3	Pass
15	0.139	0.150	93.0	0.145	0.225	64.4	Pass
16	0.015	0.115	13.0	0.017	0.173	9.9	Pass
17	0.122	0.132	92.3	0.128	0.198	64.7	Pass
18	0.015	0.102	14.3	0.020	0.153	12.8	Pass
19	0.103	0.118	86.7	0.108	0.178	60.6	Pass
20	0.015	0.092	15.8	0.020	0.138	14.2	Pass
21	0.088	0.107	82.1	0.093	0.161	57.8	Pass
22	0.015	0.084	17.7	0.017	0.125	13.4	Pass
23	0.078	0.098	80.0	0.081	0.147	55.2	Pass
24	0.015	0.077	19.8	0.018	0.115	15.2	Pass
25	0.074	0.090	82.0	0.076	0.135	56.1	Pass
26	0.016	0.071	22.5	0.019	0.107	17.6	Pass
27	0.072	0.083	86.3	0.074	0.125	59.5	Pass
28	0.016	0.066	24.4	0.018	0.099	18.4	Pass
29	0.073	0.078	93.8	0.076	0.116	64.9	Pass
30	0.019	0.061	31.2	0.036	0.092	39.1	Pass
31	0.073	0.073	99.7	0.085	0.109	77.7	Pass
32	0.027	0.058	46.7	0.039	0.086	45.7	Pass
33	0.067	0.068	98.5	0.077	0.102	75.6	Pass
34	0.017	0.054	31.4	0.020	0.081	24.1	Pass
35	0.056	0.064	87.7	0.059	0.096	61.5	Pass
36	0.017	0.051	33.7	0.020	0.077	25.9	Pass
37	0.047	0.061	77.1	0.050	0.091	54.6	Pass
38	0.018	0.048	37.5	0.022	0.073	29.7	Pass
39	0.041	0.058	71.6	0.045	0.087	52.2	Pass
40	0.013	0.046	29.1	0.016	0.069	23.1	Pass

Voltage Source Verification Data (Run time)

EUT: UPS (APS-3048SW-LCD) Tested by: SZW
 Test category: Class-A per Ed. 4.0 (2014) (European limits) Test Margin: 100
 Test date: 2015/6/13 Start time: 18:52:12 End time: 18:55:04
 Test duration (min): 2.5 Data file name: WIN2105_H-000454.cts_data
 Comment: Line Mode
 Customer: SANTAK

Test Result: Pass Source qualification: Normal

Highest parameter values during test:

V_RMS (Volts): 229.944	Frequency(Hz): 50.00
I_Peak (Amps): 15.585	I_RMS (Amps): 11.463
I_Fund (Amps): 11.448	Crest Factor: 1.487
Power (Watts): 2538.3	Power Factor: 0.996

Harm#	Harmonics V-rms	Limit V-rms	% of Limit	Status
2	0.093	0.460	20.26	OK
3	0.176	2.069	8.52	OK
4	0.040	0.460	8.70	OK
5	0.120	0.920	13.03	OK
6	0.020	0.460	4.31	OK
7	0.173	0.690	25.12	OK
8	0.020	0.460	4.27	OK
9	0.183	0.460	39.83	OK
10	0.022	0.460	4.83	OK
11	0.204	0.230	88.56	OK
12	0.020	0.230	8.56	OK
13	0.217	0.230	94.34	OK
14	0.019	0.230	8.15	OK
15	0.224	0.230	97.45	OK
16	0.022	0.230	9.56	OK
17	0.210	0.230	91.43	OK
18	0.023	0.230	9.81	OK
19	0.199	0.230	86.53	OK
20	0.021	0.230	9.32	OK
21	0.189	0.230	82.14	OK
22	0.021	0.230	9.02	OK
23	0.176	0.230	76.75	OK
24	0.021	0.230	9.32	OK
25	0.173	0.230	75.37	OK
26	0.030	0.230	12.84	OK
27	0.165	0.230	71.79	OK
28	0.024	0.230	10.27	OK
29	0.168	0.230	73.02	OK
30	0.022	0.230	9.54	OK
31	0.199	0.230	86.69	OK
32	0.048	0.230	20.67	OK
33	0.184	0.230	80.16	OK
34	0.024	0.230	10.26	OK
35	0.166	0.230	72.03	OK
36	0.022	0.230	9.43	OK
37	0.146	0.230	63.68	OK
38	0.030	0.230	12.98	OK
39	0.145	0.230	63.23	OK
40	0.030	0.230	13.20	OK

7. VOLTAGE FLUCTUATION AND FLICKER MEASUREMENT

7.1. Block Diagram of Test Setup

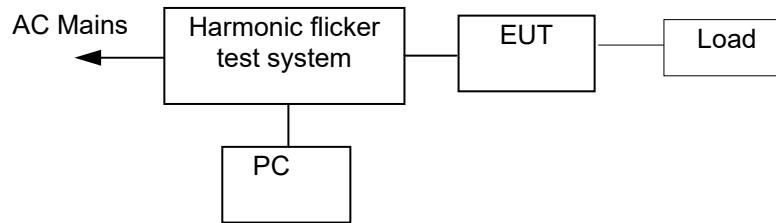

(EUT: LED Driver)

7.2. Measuring Standard

EN 61000-3-3:2013

7.3. Operation Condition of EUT

7.3.1. Setup the EUT as shown on Section 7.1.

7.3.2. Turn on the power of all equipments.

7.3.3. Let the EUT work in measuring mode (Line Mode, Bat Mode) and measure it.

7.4. Measuring Results

PASS.

Please refer to the following page.

8. IMMUNITY PERFORMANCE CRITERIA DESCRIPTION

Performance Level

The test results shall be classified in terms of the loss of function or degradation of performance of the equipment under test, relative to a performance level by its manufacturer or the requestor of the test, or the agreed between the manufacturer and the purchaser of the product.

Definition related to the performance level:

1. Based on the used product standard
2. Based on the declaration of the manufacturer, requestor or purchaser

Criterion A:

Definition: normal performance within limits specified by the manufacturer, requestor and purchaser.

The equipment shall continue to operate as intended without operator intervention. No degradation of performance or loss of function is allowed below a performance level specified by the manufacturer when the equipment is used as intended. The performance level may be replaced by a permissible loss of performance. If the minimum performance level or the permissible performance loss is not specified by the manufacturer, then either of these may be derived from the product description and documentation, and by what the user may reasonably expect from the equipment if used as intended.

Criterion B:

Definition: temporary loss of function or degradation of performance which ceases after the disturbance ceases, and from which the equipment under test recovers its normal performance, without operator intervention.

After the test, the EUT shall continue to operate as intended without operator intervention. No degradation of performance or loss of function is allowed, after the application of the phenomena below a performance level specified by the manufacturer, when the EUT is used as intended. The performance level may be replaced by a permissible loss of performance. During the test, degradation of performance is allowed. However, no change of operating state or stored data is allowed to persist after the test. If the minimum performance level (or the permissible performance loss) is not specified by the manufacturer, then either of these may be derived from the product description and documentation, and by what the user may reasonably expect from the EUT if used as intended.

Criterion C:

Definition: temporary loss of function or degradation of performance, the correction of which requires operator intervention.

Loss of function is allowed, provided the function is self-recoverable, or can be restored by the operation of the controls by the user in accordance with the manufacturer's instructions. Functions, and/or information stored in non-volatile memory, or protected by a battery backup, shall not be lost.

Criterion D

Definition: loss of function or degradation of performance, which is not recoverable, owing to damage to hardware or software, or loss of data.

9. ELECTROSTATIC DISCHARGE IMMUNITY TEST

9.1. Block Diagram of Test Setup

9.1.1. Block diagram of connection between the EUT and simulators

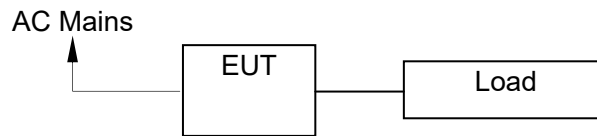

(EUT: Big power inverter)

9.1.2. Block diagram of ESD test setup

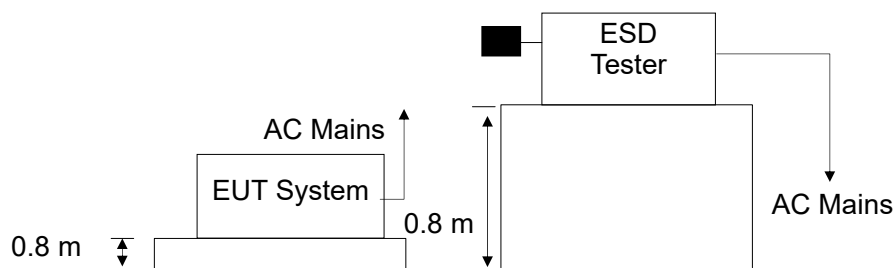

(EUT: Big power inverter)

9.2. Test Standard

IEC 61000-4-2:2008 (Air Discharge: $\pm 8\text{KV}$, Contact Discharge: $\pm 4\text{KV}$)

9.3. Severity Levels and Performance Criterion

9.3.1. Severity level

Level	Test Voltage Contact Discharge (KV)	Test Voltage Air Discharge (KV)
1.	± 2	± 2
2.	± 4	± 4
3.	± 6	± 8
4.	± 8	± 15
X	Special	Special

9.3.2. Performance criterion: B

	Criterion B
Output characteristics	Voltage permitted to vary within the inverse time characteristics applicable (<100 m sec limits in Figures 1, 2 or 3 of IEC 62040-3)
External and internal indications and metering	Change only during test
Control signals to external devices	Change only temporarily in consistency with the actual Uninterruptible Power Systems mode of operation
Mode of operation	Change only temporarily

9.4. EUT Configuration

The configuration of EUT is listed in Section 4.3.

9.5. Operating Condition of EUT

Same as the conducted emission measurement, which is listed in Section 4.4, and excepted the test set up replaced by Section 9.1.

9.6. Test Procedure

9.6.1. Air Discharge:

This test is done on a non-conductive surface. The round discharge tip of the discharge electrode shall be approached as fast as possible to touch the EUT. After each discharge, the discharge electrode shall be removed from the EUT. The generator is then re-triggered for a new single discharge and repeated 10 times for each pre-selected test point. This procedure shall be repeated until all the air discharge completed

9.6.2. Contact Discharge:

All the procedure shall be same as Section 9.6.1., and except that the tip of the discharge electrode shall touch the EUT before the discharge switch is operated.

9.6.3. Indirect discharge for horizontal coupling plane

At least 10 single discharging (in the most sensitive polarity) shall be applied at the front edge of each HCP opposite the center point of each unit (if applicable) of the EUT and 0.1m from the front of the EUT. The long axis of the discharge electrode shall be in the plane of the HCP and perpendicular to its front edge during the discharge.

9.6.4. Indirect discharge for vertical coupling plane

At least 10 single discharging (in the most sensitive polarity) shall be applied to the center of one vertical edge of the coupling plane. The coupling plane, of dimensions 0.5m X 0.5m, is placed parallel to, and positioned at a distance of 0.1m from the EUT. Discharges shall be applied to the coupling plane, with this plane in sufficient different positions that the four faces of the EUT are completely illuminated.

9.7. Test Results

PASS

Please refer to the following page.

Electrostatic Discharge Test Result

SHENZHEN EMTEK CO., LTD

Applicant : MAGNIZON POWER SYSTEMS FZE	Test Date : June 13, 2015
EUT : Big power inverter	Temperature : 22°C
M/N : APS-3048SW-LCD	Humidity : 50%
Power Supply : AC 230/50Hz	Actual Criterion : A
Test Mode : Line mode	Air discharge : ±8KV
Test Engineer : Yu Hai	Contact discharge: ±4KV
Location	Kind A-Air Discharge C-Contact Discharge
Metal	C
Slot	A
HCP	C
VCP of front	C
VCP of rear	C
VCP of left	C
VCP of right	C
Test Equipment: ESD Simulator (TESEQAG, NSG 437)	

10. RF FIELD STRENGTH SUSCEPTIBILITY TEST

10.1. Block Diagram of Test

10.1.1. Block diagram of connection between the EUT and Load

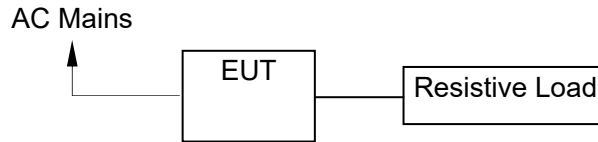

(EUT: Big power inverter)

10.1.2. Block diagram of RS test setup

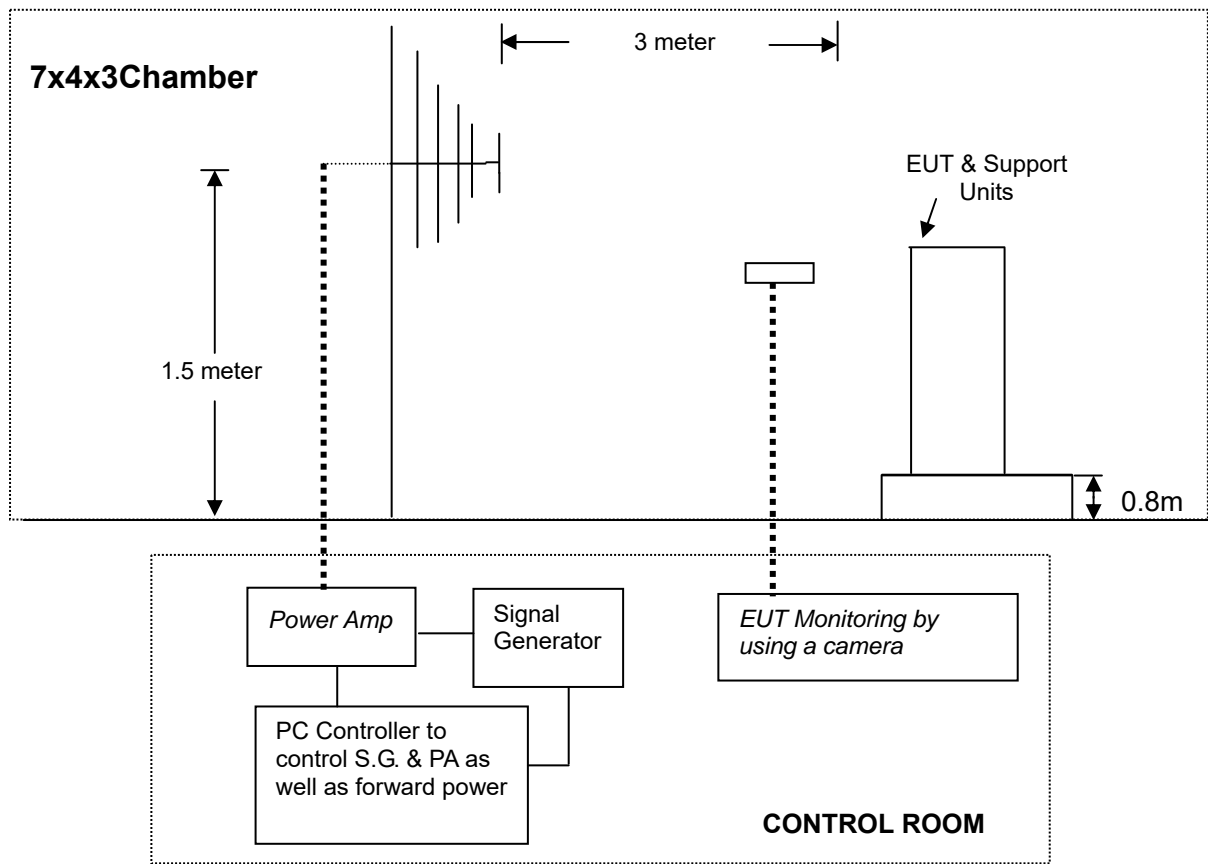

(EUT: Big power inverter)

10.2. Test Standard

IEC 61000-4-3:2006+A1:2007+A2:2010 (level 2: 3V / m)

10.3. Severity Levels and Performance Criterion

10.3.1. Severity Levels

Level	Field Strength V/m
1.	1
2.	3
3.	10
4.	30
X	Special

NOTE x is an open test level and the associated field strength may be any value. This level may be given in the product standard.

10.3.2. Performance Criterion: A

	Criterion A
External and internal indications and metering (LCD)	No change
Output characteristics (Load)	No change
Control signals to external devices (Signal line)	No change
Mode of operation	No change

10.4. EUT Configuration on Test

The configuration of the EUT is same as Section 4.3.

10.5. Operating Condition of EUT

Same as radiated emission measurement which is listed in Section 4.4, except the test setup replaced as Section 10.1.

10.6. Test Procedure

The EUT and External Battery are placed on a table which is 0.8m high above the ground. The EUT is set 3 meters away from the transmitting antenna which is mounted on an antenna tower. Both horizontal and vertical polarization of the antenna is set on test. Each of the four sides of the EUT must be faced this transmitting antenna and measured individually.

In order to judge the EUT performance, a CCD camera is used to monitor its screen. All the scanning conditions are as following:

Condition of Test	Remark
-----	-----
1. Fielded Strength	10V/m
2. Radiated Signal	Modulated
3. Scanning Frequency	80-1000MHz
4. Sweep time of radiated	0.0015 Decade/s
5. Dwell Time	1 Sec.

10.7. Test Results

PASS.

Please refer to the following page.

RF Field Strength Susceptibility Test Results

EMTEK (SHENZHEN) CO., LTD.

Applicant	: MAGNIZON POWER SYSTEMS FZE	Test Date:	June 13, 2015
EUT	: Big power inverter	Temperature:	22°C
M/N	: APS-3048SW-LCD	Humidity :	50 %
Field Strength	: 3V/m	Actual Criterion :	A
Power Supply	: AC 230/50Hz	Test Mode:	Line mode
Test Engineer:	Yu Hai	Frequency Range:	80 to 1000 MHz
Modulation: <input type="checkbox"/> None		<input type="checkbox"/> Pulse <input checked="" type="checkbox"/> AM 1KHz 80%	
	Frequency Rang 1: 80~ 1000MHz	Frequency Rang 2: N/A	
Steps	1% / 1%	/	
	Horizontal	Vertical	Horizontal
Front	A	A	
Right	A	A	
Rear	A	A	
Left	A	A	
Test Equipment : 1. Signal Generator : 2023B (AEROFLEX) 2. Power Amplifier : AP32MT215(PRANA) 3. Log-Per Antenna: VULP9118E(SCHWARZBECK) 4. RF Power Meter. Dual Channel: 4232A(BOONTON) 5. Field Strength Meter: HI-6005(HOLADAY)			
Note: /			

11. ELECTRICAL FAST TRANSIENT/BURST IMMUNITY TEST

11.1. Block Diagram of Test Setup

11.1.1. Block Diagram of the EUT

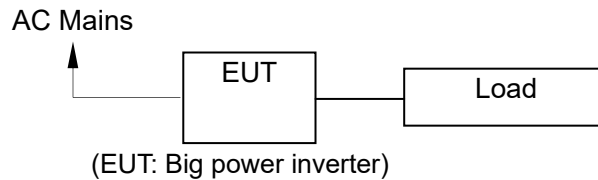

11.1.2. EFT Test Setup

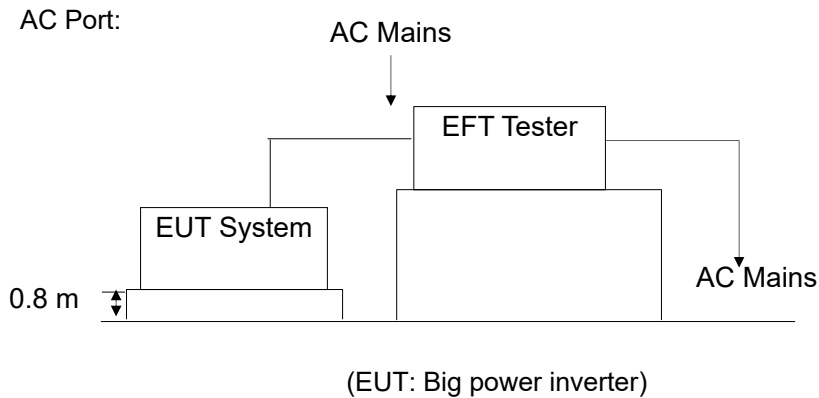

11.2. Test Standard

IEC61000-4-4:2012 (Level 2: 1KV/5kHz for AC Mains;

11.3. Severity Levels and Performance Criterion

11.3.1. Severity level

Open Circuit Output Test Voltage $\pm 10\%$		
Level	On Power Supply Lines	On I/O (Input / Output) Signal data and control lines
1.	0.5 KV	0.25 KV
2.	1 KV	0.5 KV
3.	2 KV	1 KV
4.	4 KV	2 KV
X	Special	Special

11.3.2. Performance criterion: B

Criterion B	
Output characteristics	Voltage permitted to vary within the inverse time characteristics applicable (< 100 m sec limits in Figures 1, 2 or 3 of IEC 62040-3)
External and internal indications and metering	Change only during test
Control signals to external devices	Change only temporarily in consistency with the actual Uninterruptible Power Systems mode of operation
Mode of operation	Change only temporarily

11.4.EUT Configuration

The configuration of EUT is listed in Section 4.4.

11.5.Operating Condition of EUT

11.5.1.Setup the EUT as shown in Section 11.1.

11.5.2.Turn on the power of all equipments.

11.5.3.Let the EUT work in test mode (Line mode) and measure it.

11.6.Test Procedure

The EUT and External Battery are put on the table which is 0.8m high above the ground. This reference ground plane shall project beyond the EUT by at least 0.1m on all sides and the minimum distance between EUT and all other conductive structure, except the ground plane beneath the EUT, shall be more than 0.5m.

11.6.1. For input and output AC power ports:

The EUT is connected to the power mains by using a coupling device which couples the EFT interference signal to AC power lines. Both polarities of the test voltage should be applied during compliance test and the duration of the test is 2 mins.

11.6.2. For signal line and control lines ports:

The capacitive coupling clamp shall be used for coupling the test voltage into the lines, put the signal lines into the coupling clamp, Grounding of the coaxial cable from the test generator shall be made in the vicinity of the coupling point. Both polarities of the test voltage should be applied during compliance test and the duration of the test is 2 mins.

11.6.3. For DC output line ports:

The EUT is connected to the power mains by using a coupling device which couples the EFT interference signal to DC power lines. Both polarities of the test voltage should be applied during compliance test and the duration of the test is 2 mins.

11.7.Test Result

PASS.

Please refer to the following page.

Electrical Fast Transient/Burst Test Results

EMTEK (SHENZHEN) CO., LTD.

Standard	IEC 61000-4-4	Result: <input checked="" type="checkbox"/> PASS / <input type="checkbox"/> FAIL	
Applicant : <u>MAGNIZON POWER SYSTEMS FZE</u>			
EUT : <u>Big power inverter</u>			
M/N : <u>APS-3048SW-LCD</u>			
Input Voltage: <u>AC 230/50Hz</u>			
Actual Criterion : B			
Ambient Condition : <u>23 °C</u>		<u>52% RH</u>	
Operation Mode: Line mode			
Line : <input checked="" type="checkbox"/> AC input and output power ports		Line : <input type="checkbox"/> Signal <input type="checkbox"/> DC line	
Coupling : <input checked="" type="checkbox"/> Direct		Coupling : <input type="checkbox"/> Capacitive	
Test Time : 120s			
Line	Test Voltage	Result(+)	Result(-)
L	1kV	A	A
N	1kV	A	A
PE	1kV	A	A
L、N	1kV	A	A
L、PE	1kV	A	A
N、PE	1kV	A	A
L、N、PE	1kV	A	A
Signal Line			
DC Line			
Note: /			
Test Equipment		Burst Tester Model : PEFT 4010, CDN 163	

12. SURGE IMMUNITY TEST

12.1. Block Diagram of Test Setup

12.1.1. Block Diagram of the EUT

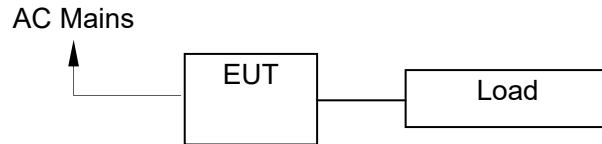

(EUT: Big power inverter)

12.1.2. Surge Test Setup

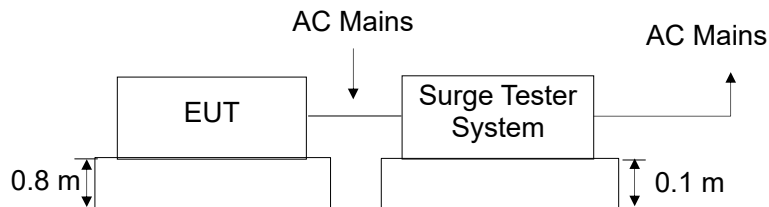

(EUT: Big power inverter)

12.2. Test Standard

IEC 61000-4-5:2005 (Line to Line: Level 4, 1.0KV, Line to earth: Level 4, 2.0KV)

12.3. Severity Levels and Performance Criterion

12.3.1. Severity level

Severity Level	Open-Circuit Test Voltage KV
1	0.5
2	1.0
3	2.0
4	4.0
*	Special

12.3.2. Performance criterion: B

	Criterion B
Output characteristics	Voltage permitted to vary within the inverse time characteristics applicable (<100 m sec limits in Figures 1, 2 or 3 of IEC 62040-3)
External and internal indications and metering	Change only during test
Control signals to external devices	Change only temporarily in consistency with the actual Uninterruptible Power Systems mode of operation
Mode of operation	Change only temporarily

12.4.EUT Configuration

The configuration of EUT is listed in Section 4.3.

12.5.Operating Condition of EUT

12.5.1.Setup the EUT as shown in Section 12.1.

12.5.2.Turn on the power of all equipments.

12.5.3.Let the EUT work in test mode (Line mode) and measure it.

12.6.Test Procedure

- 1) Set up the EUT and test generator as shown on Section 12.1.2.
- 2) For line to line coupling mode, provide 1.0KV 1.2/50us voltage surge, for line to earth mode, provide 2.0KV 1.2/50us voltage surge (at open-circuit condition) and 8/20us current surge to EUT selected points.
- 3) At least 5 positive and 5 negative (polarity) tests with a maximum 1/min repetition rate are conducted during test.
- 4) Different phase angles are done individually.
- 5) Record the EUT operating situation during compliance test and decide the EUT immunity criterion for above each test.

12.7.Test Result

PASS.

Please refer to the following page.

Surge Immunity Test Result

EMTEK (SHENZHEN) CO., LTD.

Applicant: <u>MAGNIZON POWER SYSTEMS FZE</u>				Test Date : <u>June 13, 2015</u>	
EUT : <u>Big power inverter</u>				Temperature : <u>23°C</u>	
M/N : <u>APS-3048SW-LCD</u>				Humidity : <u>51%</u>	
Power Supply: <u>AC 230/50Hz</u>				Test Mode : <u>Line mode</u>	
Test Engineer: <u>Yu Hai</u>				Actual Criterion : <u>A</u>	
Location	Polarity	Phase Angle	Number of Pulse	Pulse Voltage (KV)	Result
L-N	+	0°	5	1.0	A
	+	90°	5	1.0	A
	+	180°	5	1.0	A
	+	270°	5	1.0	A
	-	0°	5	1.0	A
	-	90°	5	1.0	A
	-	180°	5	1.0	A
	-	270°	5	1.0	A
N-PE	+	0°	5	2.0	A
	+	90°	5	2.0	A
	+	180°	5	2.0	A
	+	270°	5	2.0	A
	-	0°	5	2.0	A
	-	90°	5	2.0	A
	-	180°	5	2.0	A
	-	270°	5	2.0	A
L-PE	+	0°	5	2.0	A
	+	90°	5	2.0	A
	+	180°	5	2.0	A
	+	270°	5	2.0	A
	-	0°	5	2.0	A
	-	90°	5	2.0	A
	-	180°	5	2.0	A
	-	270°	5	2.0	A
Remark: /					
Test Equipment model: Psurge 8000, PIM 100, PCD 130					

13. INJECTED CURRENTS SUSCEPTIBILITY TEST

13.1. Block Diagram of Test Setup

13.1.1. Block Diagram of the EUT

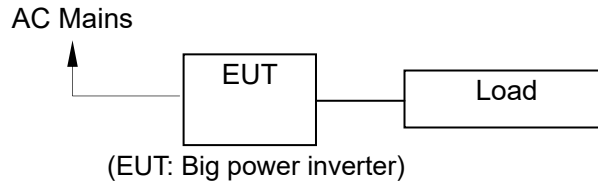

13.1.2. Block Diagram of Test Setup

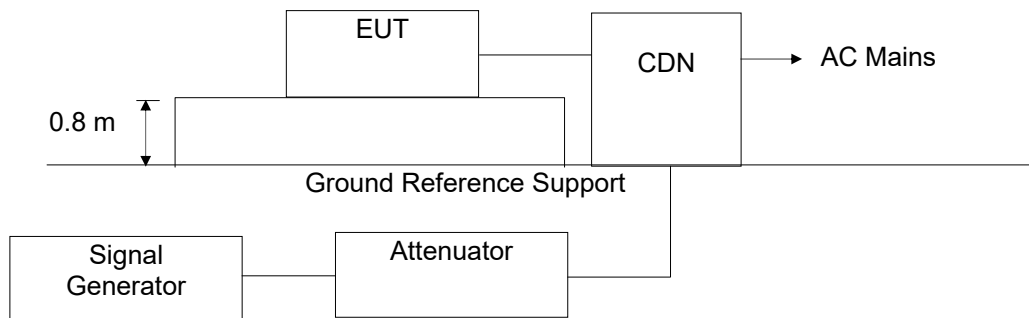

13.2. Test Standard

IEC 61000-4-6:2008 (Level 2: 3V (rms), (0.15MHz ~ 80MHz))

13.3. Severity Levels and Performance Criterion

13.3.1. Severity level

Level	Field Strength V
1	1
2	3
3	10
X	Special

13.3.2. Performance criterion: A

	Criterion A
External and internal indications and metering (LCD)	No change
Output characteristics (Load)	No change
Control signals to external devices (Signal line)	No change
Mode of operation	No change

13.4.EUT Configuration

The configuration of EUT is listed in Section 4.3.

13.5.Operating Condition of EUT

13.5.1.Setup the EUT as shown in Section 13.1.

13.5.2.Turn on the power of all equipments.

13.5.3.Let the EUT work in test mode (Line mode) and measure it.

13.6.Test Procedure

- 1) Set up the EUT, CDN and test generators as shown on Section 13.1.2.
- 2) Let the EUT work in test mode and measure it. The EUT are placed on an insulating support 0.1m high above a ground reference plane. CDN (coupling and decoupling device) is placed on the ground plane about 0.3m from EUT. Cables between CDN and EUT are as short as possible, and their height above the ground reference plane shall be between 30 and 50 mm (where possible).
- 3) The disturbance signal described below is injected to EUT through CDN.
- 4) The EUT operates within its operational mode(s) under intended climatic conditions after power on.
- 5) The frequency range is swept from 150 KHz to 80MHz using 10V signal level, and with the disturbance signal 80% amplitude modulated with a 1 KHz sine wave.
- 6) The rate of sweep shall not exceed $1.5 \cdot 10^{-3}$ decades/s. Where the frequency is swept incrementally, the step size shall not exceed 1% of the start and thereafter 1% of the preceding frequency value.
- 7) Recording the EUT operating situation during compliance testing and decide the EUT immunity criterion.

13.7.Test Results

PASS.

Please refer to the following page.

Injected Currents Susceptibility Test Results

EMTEK (SHENZHEN) CO., LTD.

Applicant : <u>MAGNIZON POWER SYSTEMS FZE</u> EUT : <u>Big power inverter</u> M/N : <u>APS-3048SW-LCD</u> Power Supply : <u>AC 230/50Hz</u> Test Engineer : <u>Yu Hai</u>			Test Date: <u>June 13, 2015</u> Temperature : <u>23°C</u> Humidity : <u>50%</u> Actual Criterion : <u>A</u>	
Test Mode : <u>Line mode</u>				
Frequency Range (MHz)	Injected Position	Strength (Unmodulated)	Criterion	Result
0.15 ~ 80	AC Mains	3V	A	A
Remark : 1. Modulation Signal:1kHz 80% AM Measurement Equipment : Simulator: CIT-10 (SWITZERLAND EMTEST) CDN : <input type="checkbox"/> CDN-M2 (SWITZERLAND EMTEST) <input checked="" type="checkbox"/> CDN-M3 (SWITZERLAND EMTEST)			Note: /	

14. MAGNETIC FIELD SUSCEPTIBILITY TEST

14.1. Block Diagram of Test

14.1.1. Block diagram of test setup

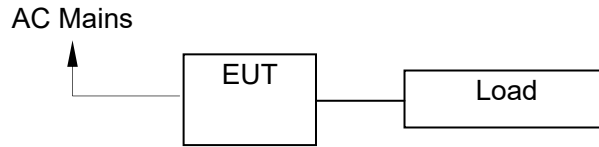

(EUT: Big power inverter)

14.1.2. Magnetic field test setup

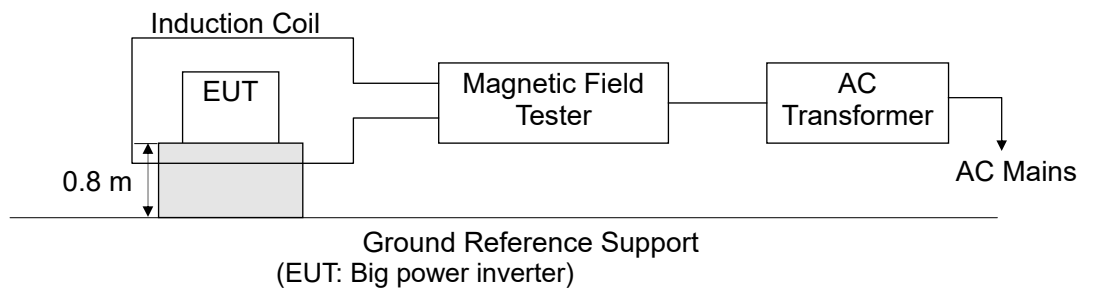

(EUT: Big power inverter)

14.2. Test Standard

IEC 61000-4-8:2009, (Severity Level 2: 3A / m)

14.3. Severity Levels and Performance Criterion

14.3.1. Severity Levels

Level	Field Strength A/m
1	1
2	3
3	10
4	30
5	100
X	Special

14.3.2. Performance Criterion: A

	Criterion A
Output characteristics	Voltage permitted to vary within the inverse time characteristics applicable (<100 m sec limits in Figures 1, 2 or 3 of IEC 62040-3)
External and internal indications and metering	Change only during test
Control signals to external devices	Change only temporarily in consistency with the actual Uninterruptible Power Systems mode of operation
Mode of operation	Change only temporarily

14.4.EUT Configuration on Test

The configuration of the EUT is same as Section 4.3.

14.5.Test Procedure

The EUT and External Battery are placed in the middle of a induction coil (1*1m), under which is a 1*1*0.1m (high) table, this small table is also placed on a larger table, 0.1 m above the ground. Both horizontal and vertical polarization of the induction coil is set on test, so that each side of the EUT is affected by the magnetic field. Also it can reach the same aim by change the position of the EUT.

14.6.Test Results

PASS.

Please refer to the following page.

Magnetic Field Immunity Test Result

EMTEK (SHENZHEN) CO., LTD.

Standard	IEC 61000-4-8		Result: <input checked="" type="checkbox"/> Pass / <input type="checkbox"/> Fail	
Applicant : <u>MAGNIZON POWER SYSTEMS FZE</u> EUT : <u>Big power inverter</u> M/N: <u>APS-3048SW-LCD</u> Input Voltage : <u>AC 230/50Hz</u> Date of Test : <u>June 13, 2015</u> Test Engineer: <u>Yu Hai</u> Ambient Condition : Temp : <u>22°C</u> Humid: <u>58%</u> Actual Criterion : A				
Operation Mode : Line mode				
Test Level (A/M)	Testing Duration	Coil Orientation	Criterion	Result
3	5 mins	X	A	A
3	5 mins	Y	A	A
3	5 mins	Z	A	A
Operation Mode : N/A				
Test Level (A/M)	Testing Duration	Coil Orientation	Criterion	Result
/	/	/	/	/
/	/	/	/	/
Test Equipment	Magnetic Field Test : HEAFELY MAG 100.1			
Note: /				

15. LOW FREQUENCY SIGNALS TEST

15.1. Block Diagram of Test Setup

15.1.1. Block Diagram of the EUT

For Normal:

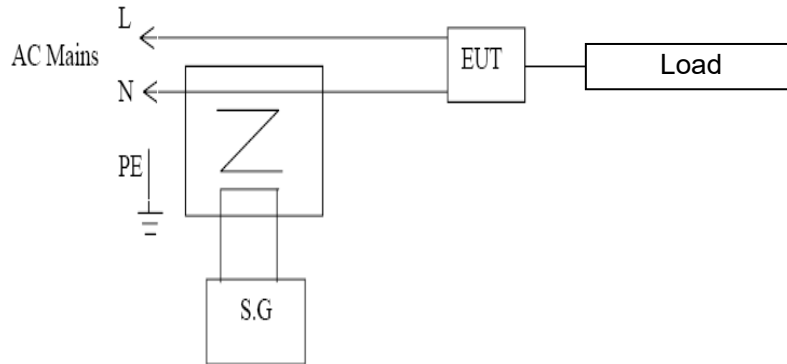

(EUT: Big power inverter)

15.2. Test Standard

IEC 61000-2-2:2002, Performance: A

	Criterion A
External and internal indications and metering (LCD)	No change
Output characteristics (Load)	No change
Control signals to external devices (Signal line)	No change
Mode of operation	No change

15.3. Operating Condition of EUT

Same as Section 4.4, Except the test setup replaced by Section 15.1.

15.4. Test Results

PASS.

Please refer to following pages.

Low Frequency Signals Test Result

EMTEK (SHENZHEN) CO., LTD.

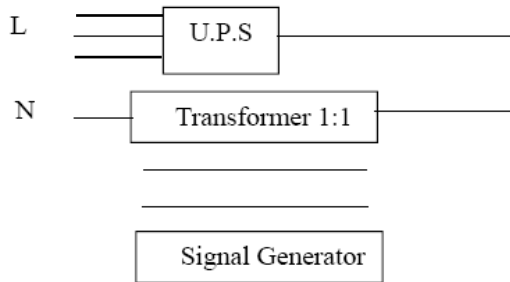
Applicant: <u>MAGNIZON POWER SYSTEMS FZE</u> EUT : <u>Big power inverter</u> M/N : <u>APS-3048SW-LCD</u> Power Supply : <u>AC 230/50Hz</u> Test Engineer : <u>Yu Hai</u>				Test Date: <u>June 13, 2015</u> Temperature : <u>22°C</u> Humidity : <u>50%</u> Test Mode : <u>Line mode</u> Actual Criterion : <u>A</u>	
Frequency Range (Hz)	Step (Hz)	Position	Strength	Result	Note
140	10	See Fig.1	10V(rms) Sinusoidal	P	PASS
160				P	PASS
200				P	PASS
240				P	PASS
280				P	PASS
320				P	PASS
360				P	PASS
Note: This result for normal. 			Test Equipment: 1. Isolation transformer Primary: Secondary=1:1 2. Signal Generator AC Source: 65930 (Chroma)		

16. TEST PHOTOGRAPH

16.1.Photos of Conducted Emission Measurement



16.2. Photo of Radiation Emission Measurement

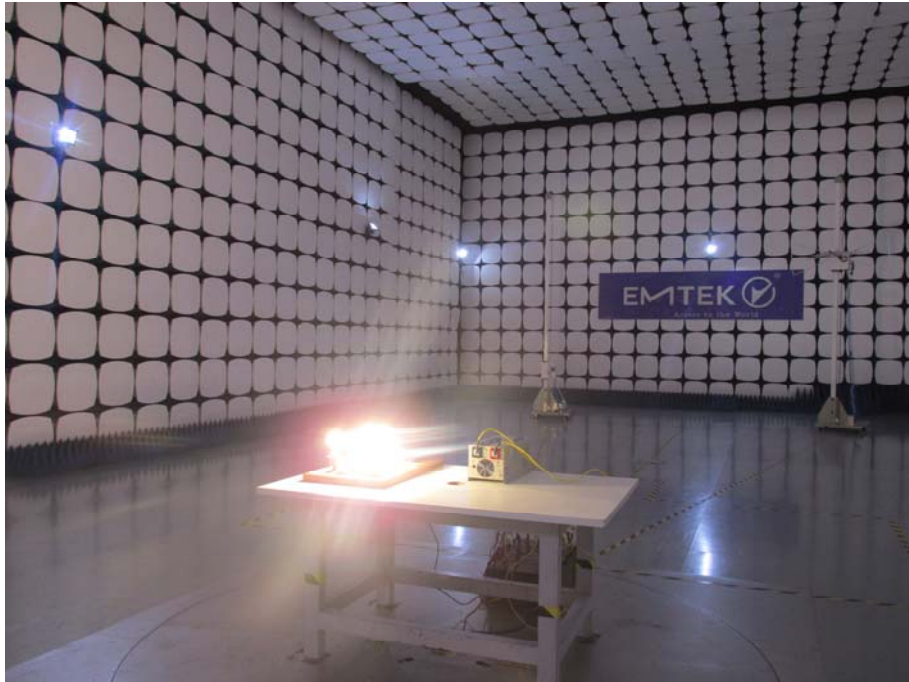

16.3. Photo of Harmonic Measurement



16.4. Photo of Electrostatic Discharge Test

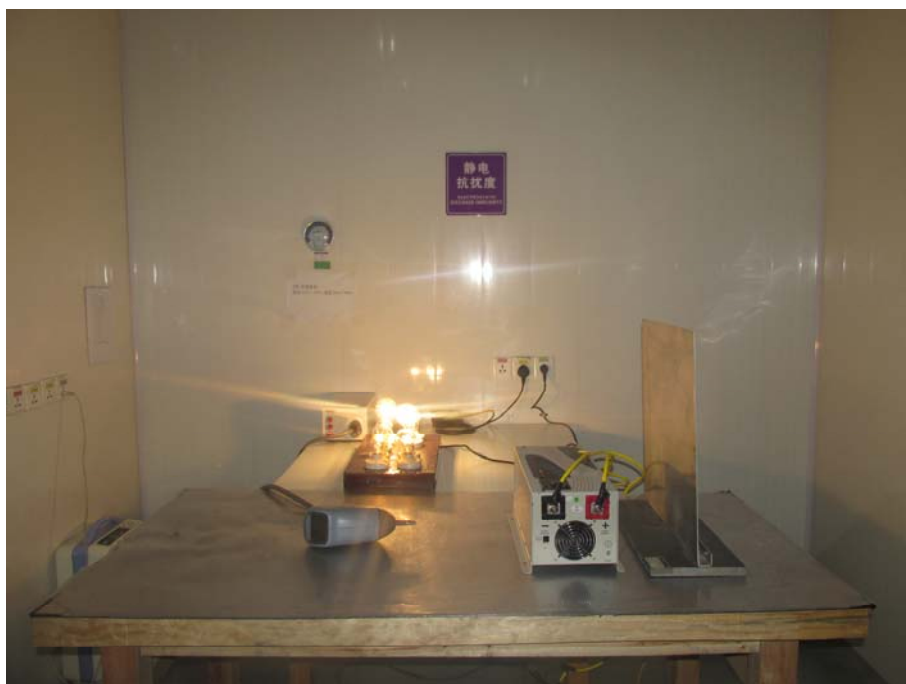

16.5. Photo of RF Field Strength susceptibility Test



16.6. Photos of Electrical Fast Transient /Burst Test



16.7.Photo of Surge Test



16.8.Photo of Injected Currents Susceptibility Test

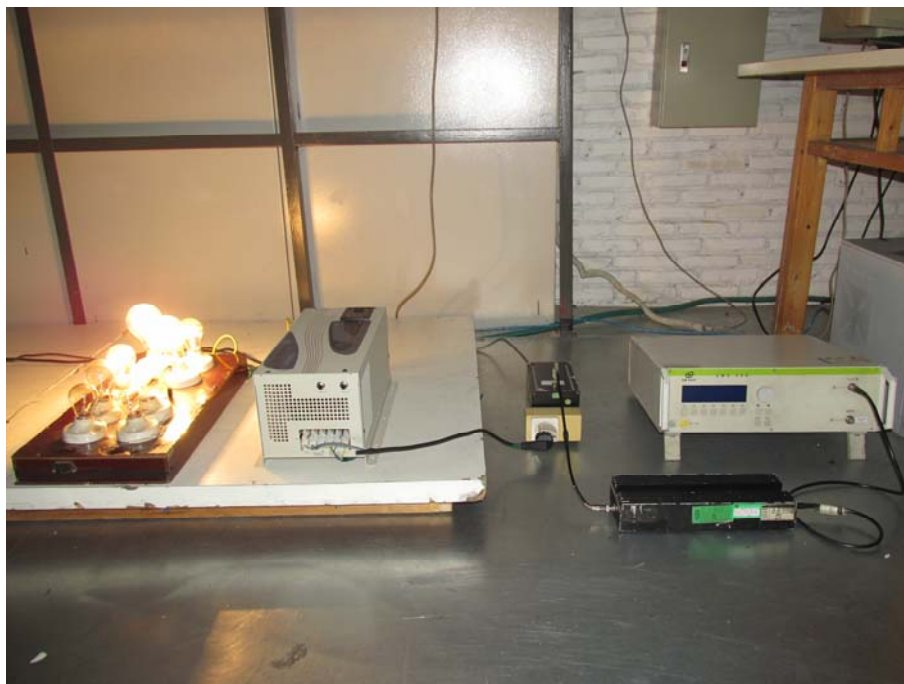

16.9. Photo of Magnetic Field Immunity Test



16.10. Photo of Low Frequency Signals Test



APPENDIX (Photos of EUT)

APS-3048SW-LCD:



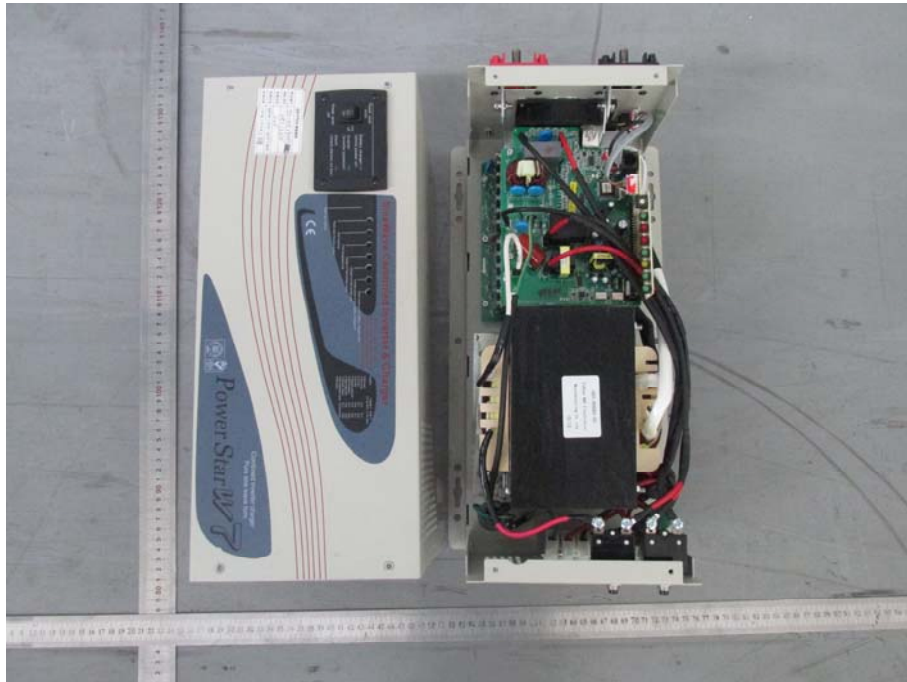

APS-5048SW-LCD:





APS-6048SW-LCD:





-----The end-----